

Multifunction LCD Digital Timer/Counter/Tachometer TC-Pro482 Series



User's Manual

Ver:3.0



Multifunction LCD Digital Timer/Counter/Tachometer

TC-Pro482xxx

- Highly visible display with backlit negative transmissive LCD
- Visual alert when output status changes
- PNP/NPN switchable DC-voltage input
- Finger-safe terminals(screw terminal block models)
- Three-language instruction manual
- Applied to connect PC/HMI

Contents

Model Number Structure	2
Specifications	3
Nomenclature	6
Operating Procedures	9
Timer Function	12
Twin Timer Function	15
2-Stage Timer Function	17
Counter Function	20
Tachometer Function	23
Sequence Charts	26
Dimensions	38
Input Connections	40
Safety Precautions	42
Additional Information	44
List of Settings	47

Model Number Structure

■ List of Models

Output type	Supply voltage	Model	
		Standard	Communication
Contact output	100~240 VAC	TC-Pro482SRA (-D)	TC-Pro482CRA (-D)
	24 VDC/24 VAC	TC-Pro482SRD (-D)	TC-Pro482CRD (-D)
Transistor output	100~240 VAC	TC-Pro482STA (-D)	TC-Pro482CTA (-D)
	24 VDC/24 VAC	TC-Pro482STD (-D)	TC-Pro482CTD (-D)

Note: The model with communication must be used with cable.

■ Model Number Legend

TC-Pro 482 -
 1 2 3 4

1. Communication

S: Standard (no communication)

C: Communication

2. Output type

R: Contact

T: Transistor

3. Supply voltage

A: 100V~240VAC

D: 24VDC、24VAC

4. Mounting method

None: Flush mounting

D: DIN track mounting

■ Accessories (Order Separately)

Name	Models
9-pin Female D-sub cable for RS-232 connector, 1.5m Cable	CAB-090A232
9-pin Female D-sub cable for RS-485 connector, 1.5m Cable	CAB-090A485
9-pin Female D-sub cable for RS-422 connector, 1.5m Cable	CAB-090A422
9-pin male D-sub adapter for CAB-090A232/CAB-090A485/CAB-090A422	ADP-090401
9-pin Female D-sub cable for RS-232 connector, 1.5m Cable	CAB-090B232
9-pin Female D-sub cable for RS-485 connector, 1.5m Cable	CAB-090B485
9-pin Female D-sub cable for RS-422 connector, 1.5m Cable	CAB-090B422
Mounting Track	0F-A
Panel Protective Cover	SVF-A
Communication Protective Cover	TTL-11

Note : CAB-090A232/485/422 is used for Flush mounting products

CAB-090B232/485/422 is used for DIN track mounting products

Specifications

■ Ratings (For Timing)

Item	TC-Pro482□□□-□
Classification	Digital timer/counter/tachometer
Rated supply voltage	100~240VAC (50/60Hz), 24VAC (50/60Hz), 24VDC (permissible ripple:20% (p-p) max.)
Operating voltage range	85% to 110% rated supply voltage (24VDC; 90% to 110%)
Power consumption	Approx. 6.2VA at 264VAC, Approx. 5.1VA at 26.4VAC, Approx. 2.4W at 24VDC
Mounting method	Flush mounting, DIN track mounting
External connections	Screw terminals
Terminal screw tightening torque	0.5 N•m Max.
Display	7-segment, LCD display Present value: 9-mm-high characters, white Set value: 4-mm-high characters, white
Digits	6 digits
Time range	999.999s (0.001-s unit), 9999.99s (0.01-s unit), 99999.9s (0.1-s unit) 999999s (1-s unit), 9999min59s (1-s unit), 99999.9min (0.1-min unit), 999999min (1-min unit), 9999h59min (1-min unit), 99999.9h (0.1-h unit), 999999h (1-h unit)
Timer mode	Elapsed time (UP), Remaining time (down) (selectable)
Input signals	Signal, reset, gate
Input method	※ No-voltage input/voltage input (switchable) ◆ No-voltage input ON impedance: 1kΩ max. (leakage current: 5~20 mA at 0Ω) ON residual voltage: 3V max. OFF impedance: 100kΩ min. ◆ Voltage Input High (logic) level: 4.5 to 30 VDC Low (logic) level: 0 to 2 VDC (Input resistance: approx. 4.7 kΩ)
Signal, Reset, Gate	Minimum input signal width: 1 or 20 ms (selectable, same setting for all inputs)
Power reset	Minimum power-opening time: 0.5 s (except A-3, b-1 and F mode)
Reset system	Power reset (except A-3, b-1 and F mode), external and manual reset
Sensor waiting time	250 ms max. (control output is turned OFF and no input is accepted during sensor waiting time)
Output modes	A, A-1, A-2, A-3, b, b-1, d, E, F, Z, ton or toff
One-shot output time	0000.01~9999.99s
Output method	Relay/transistor output
Control output	SPDT contact output: 5A at 250 VAC, resistive load (cosΦ=1) Minimum applied load: 10 mA at 5 VDC (failure level: P, reference value) Transistor output: NPN open collector, max. 100mA at 30 VDC Residual voltage: 1.5 VDC max. (approx. 1V) Output category according to EN60947-5-1 for timers with Contact outputs (AC-15; 250V 3A / AC-13; 250V 5A / DC-13; 30V 0.5A) Output category according to EN60947-5-2 for timers with Transistor outputs (DC-13; 30V 100 mA) NEMA B300 Pilot Duty, 1/4 HP 5-A resistive load at 120 VAC, 1/3 HP 5-A resistive load at 240 VAC
External power supply	12VDC (15%), 80mA
Key protection	Yes
Memory backup	EEPROM (overwrites: 100,000 times min.) that can store data for 10 years min.

■ Ratings (For Counting)

Item	TC-Pro482□□□□□
Classification	Digital timer
Supported configurations	1-stage counter, 2-stage counter, total counter, batch counter, dual counter, and tachometer (selectable)
Rated supply voltage	100~240VAC (50/60Hz), 24VAC (50/60Hz), 24VDC (permissible ripple: 20% (p-p) max.)
Operating voltage range	85% to 110% rated supply voltage(24VDC; 90% to 110%)
Power consumption	Approx. 6.2VA at 264VAC, Approx. 5.1VA at 26.4VAC, Approx. 2.4W at 24VDC
Mounting method	Flush mounting, DIN track mounting
External connections	Screw terminals
Terminal screw tightening torque	0.5 N•m Max.
Display	7-segment, LCD display Present value: 9-mm-high characters, white Set value: 4-mm-high characters, white
Digits	6 digits, PV/SV (-99,999~999,999)
Input method	CP1, CP2, reset1, and reset 2
Max. counting speed	30 Hz or 5kHz (selectable, ON/OFF ratio 1:1), common setting for CP1 and CP2
Input mode	Increment, decrement, command, individual, and quadrature
Input method	<ul style="list-style-type: none"> ※ No-voltage input/voltage input (switchable) ◆ No-voltage input ON impedance: 1kΩ max. (leakage current: 5~20 mA when 0Ω) ON residual voltage: 3V max. OFF impedance: 100kΩ min. ◆ Voltage Input High(logic) level: 4.5 to 30 VDC Low(logic) level: 0 to 2 VDC (Input resistance: approx. 4.7 kΩ)
Reset input	Minimum input signal width: 1/20 ms (selectable, same setting for all inputs)
Reset system	External, manual, and automatic reset (internal according to C,R,P and Q mode operation)
Output modes	N,F,C,R,K-1,P,Q,A,K-2,D,L,H
One-shot output time	000.001~9999.99s
Output method	Relay/transistor output
Control output	SPDT contact output: 5A at 250 VAC, resistive load (cosΦ=1) Minimum applied load: 10 mA at 5 VDC (failure level: P, reference value) Transistor output: NPN open collector, max. 100mA at 30 VDC Residual voltage: 1.5 VDC max. (approx. 1V) Output category according to EN60947-5-1 for timers with Contact outputs (AC-15; 250V 3A / AC-13; 250V 5A / DC-13; 30V 0.5A) Output category according to EN60947-5-2 for timers with Transistor outputs (DC-13; 30V 100 mA) NEMA B300 Pilot Duty, 1/4 HP 5-A resistive load at 120 VAC, 1/3 HP 5-A resistive load at 240 VAC
External power supply	12VDC(15%), 80mA
Key protection	Yes
Prescaling function	Yes (000.001~999.999)
Decimal point adjustment	Yes (rightmost 3 digits)
Sensor waiting time	250 ms max. (Control output is turned OFF and no input is accepted during sensor waiting time.)
Memory backup	EEPROM (overwrites: 100,000 times min.) that can store data for 10 years min.
Ambient temperature	Operating: -10 to 55°C (with no icing or condensation) Storage: -25 to 65°C (with no icing or condensation)
Ambient humidity	25% to 85%
Case color	Flush mode: black, DIN track mode: gray-black
Attachments	Waterproof packing, flush mounting adapter

■ Characteristics

Item	TC-Pro482□□□□-□
Life expectancy	Mechanical: 10,000,000 operations min. Electrical: 100,000 operations min. (5 A at 250 VAC, resistance load)
EMC	(EMI) Emission Enclosure: EN61326 Emission AC mains: EN55011 (EMS) Immunity ESD: EN61326 Immunity RF-interference: EN61000-4-2 Immunity Conducted Disturbance: EN61000-4-3 Immunity Burst: EN61000-4-6 Immunity Surge: EN61000-4-4 Immunity voltage Dip/interruption: EN61000-4-5 EN61000-4-11
Weight	Approx. 168g

Nomenclature

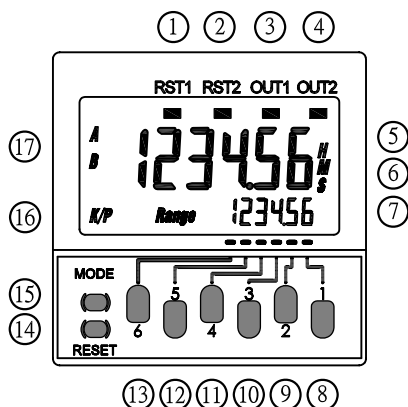

- ① ② Reset Indicator
- ③ ④ Control Output Indicator
- ⑤ Present Value (character height: 9 mm)
- ⑥ Time Unit Display (If the time range is 0 min, 0.0 min, 0 h, 0.0 h, 0h0 min, this display flashes to indicate timing operation)
- ⑦ Set Value (character height: 4 mm)
- ⑧ The First Setting Key
- ⑨ The Second Setting Key
- ⑩ The Third Setting Key
- ⑪ The Fourth Setting Key
- ⑫ The Fifth Setting Key
- ⑬ The Sixth Setting Key
- ⑭ Reset Key (resets present value and output)
- ⑮ Mode Key (changes modes and setting items)
- ⑯ Key Protection Indicator (the preset value is OFF)
- ⑰ Set Value (Range) A, B Display

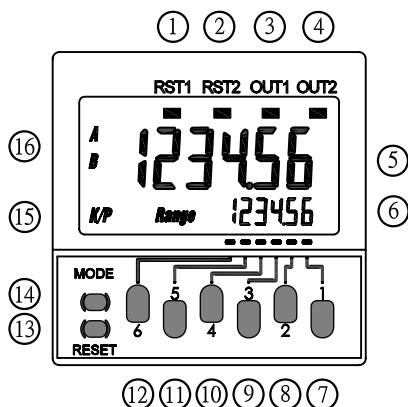

- ① ② Reset Indicator
- ③ ④ Control Output Indicator
- ⑤ Present Value (character height: 9 mm)
- ⑥ Set Value (character height: 4 mm)
- ⑦ The First Setting Key
- ⑧ The Second Setting Key
- ⑨ The Third Setting Key
- ⑩ The Fourth Setting Key
- ⑪ The Fifth Setting Key
- ⑫ The Sixth Setting Key
- ⑬ Reset Key (resets present value and output)
- ⑭ Mode Key (changes modes and setting items)
- ⑮ Key Protection Indicator (the preset value is OFF)
- ⑯ Set Value (Range) A, B Display

■ Reset Operation by Reset Key

Configuration	Reset operation
1-stage/2-stage counter	Resets the present value and outputs
Total counter	Resets the present value and outputs When the total count value is displayed, resets the present value, the total count value, and outputs.
Batch counter	Resets the present value and OUT1 When the batch count value is displayed, resets the present value, the batch count value, and outputs.
Dual counter tachometer	Resets the CP1 present value, CP2 present value, dual count value and outputs Maintains the measured value and outputs

■ Block Diagram

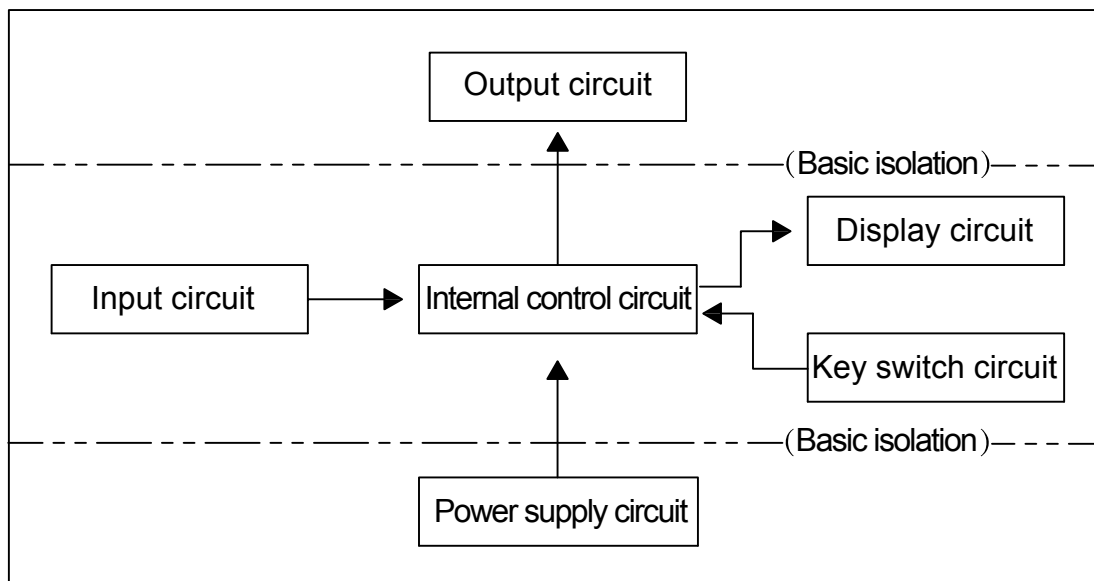

■ I/O Functions (Timer/Twin Timer)

Input	Start signal	Stops timing in A-2 and A-3 (power ON delay) modes Starts timing in other modes
	Reset	Reset present value (In elapsed time mode, the present value returns to 0; in remaining time mode, the present value returns to the set value) Count inputs are not accepted and control output turns OFF while reset input is ON. Reset indicator is lit while reset input is ON.
	Gate	Inhibits timer operation
Outputs	Control output (OUT)	Outputs take place according to designated operating mode when timer reaches corresponding set value.

Note: Two control outputs can be used.

■ I/O Functions (2-Stage Timer)

Inputs	Start signal		Starts timing
	Reset		Resets present value (the present value returns to 0) Timing inputs are not accepted and control output turns OFF while reset input is ON. Reset indicator is lit while reset input is ON.
	Gate		Inhibits timer operation
Outputs	Forecast value setting	Control output (OUT2)	Turn ON when the present value reaches the set value.
		Forecast output (OUT1)	Turn ON when the present value reaches the forecast value. The forecast value=set value-forecast set value
	Absolute value setting	Control output 2 (OUT2)	Turn ON when the present value reaches the set value 2.
		Control output 1 (OUT1)	Turn ON when the present value reaches the set value 1.

■ I/O Functions (Counter)

Inputs	CP1, CP2	<ol style="list-style-type: none"> In general (except for dual counter mode) Reads counting signals Increment, decrement, command, individual, and quadrature inputs accepted. When used as a dual counter Reads CP1 count signals with CP1 input and CP2 count signals with CP2 input. Increment signals can be input.
	Reset or Reset 1	<ol style="list-style-type: none"> In general (except for dual counter mode) Resets present value and outputs Counting can not be performed during reset/reset 1 input The 3reset indicator is lit during reset input. When used as a dual counter Resets CP1 present value Counting for CP1 input can not be performed during reset 1 input. The reset indicator is lit during reset 1 input.
	Total Reset or Reset 2 (see note 2.)	<ol style="list-style-type: none"> When used as 1-stage/2-stage counter Does not operate (Not used). When used as a total and present counter Resets the total count value Hold the total count value at 0 during total reset input When used as a batch counter Reset the batch count value and batch output (OUT1) Holds the batch count value at 0 during total reset 2 input When used as a dual counter Resets the CP2 present value Counting for CP2 input can not be performed during reset 2 input
Output	Control output (OUT)	Outputs take place according to designated output mode when corresponding preset is reached.

Note:

- In increment mode or increment/decrement mode, the present value returns to 0, in decrement mode, the present value returns to the set value with 1-stage models, and returns to set value 2 with 2-stage models.
- The reset indicator will not be lit when the total reset or reset 2 input is ON.

■ I/O Functions (Tachometer)

Inputs	CP1, CP2	Reads counting signals. (CP2 input is not used)
	RESET1, RESET2	Holds the measurement value and outputs. (CP2 input is not used) The reset indicator is lit during hold.
Outputs	OUT1, OUT2	Outputs signals according to the specified output mode when a set value is reached.

Operating Procedures

■ Timer/Twin Timer/2-stage Timer Selection Mode

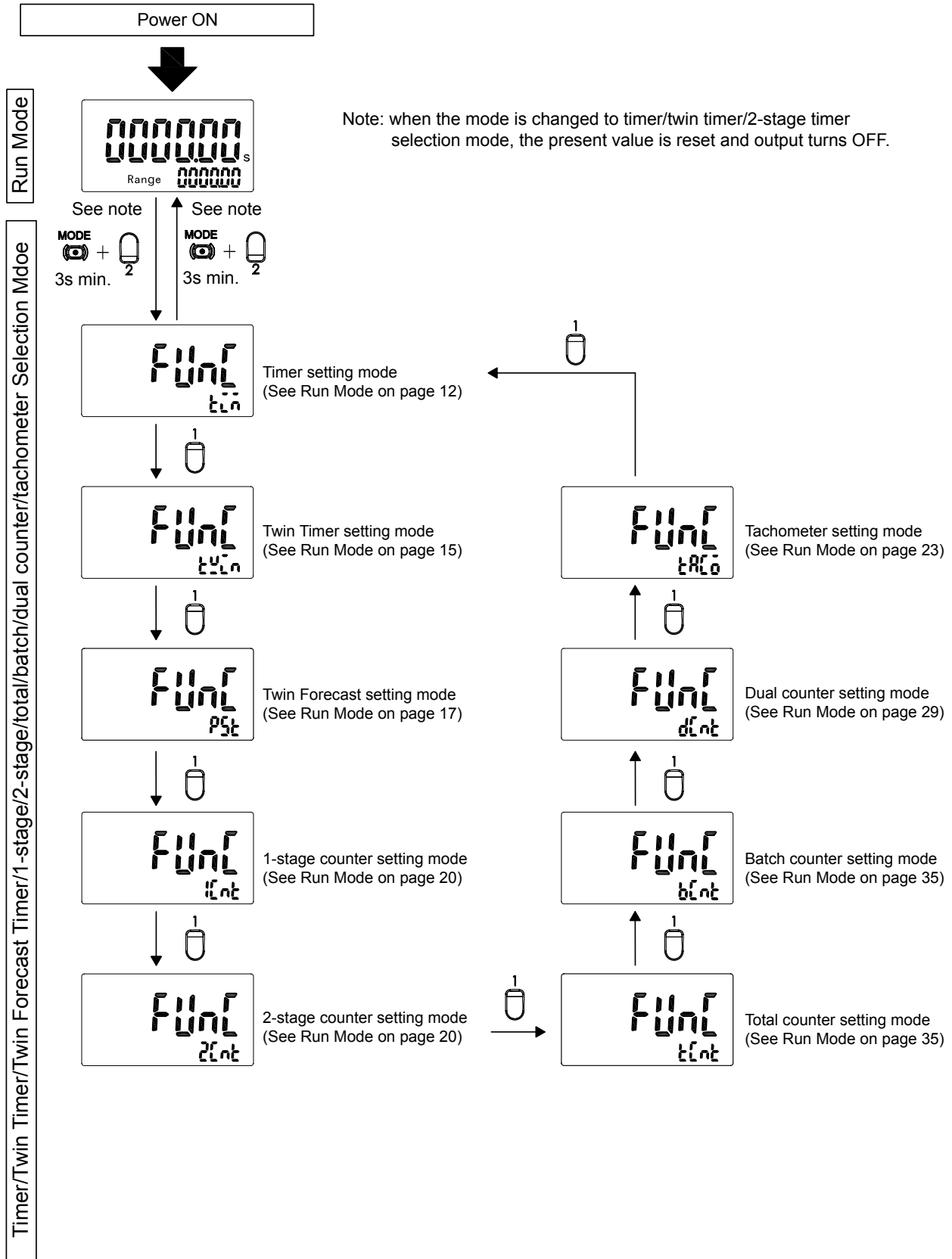

■ Communication Format Function Selection Mode

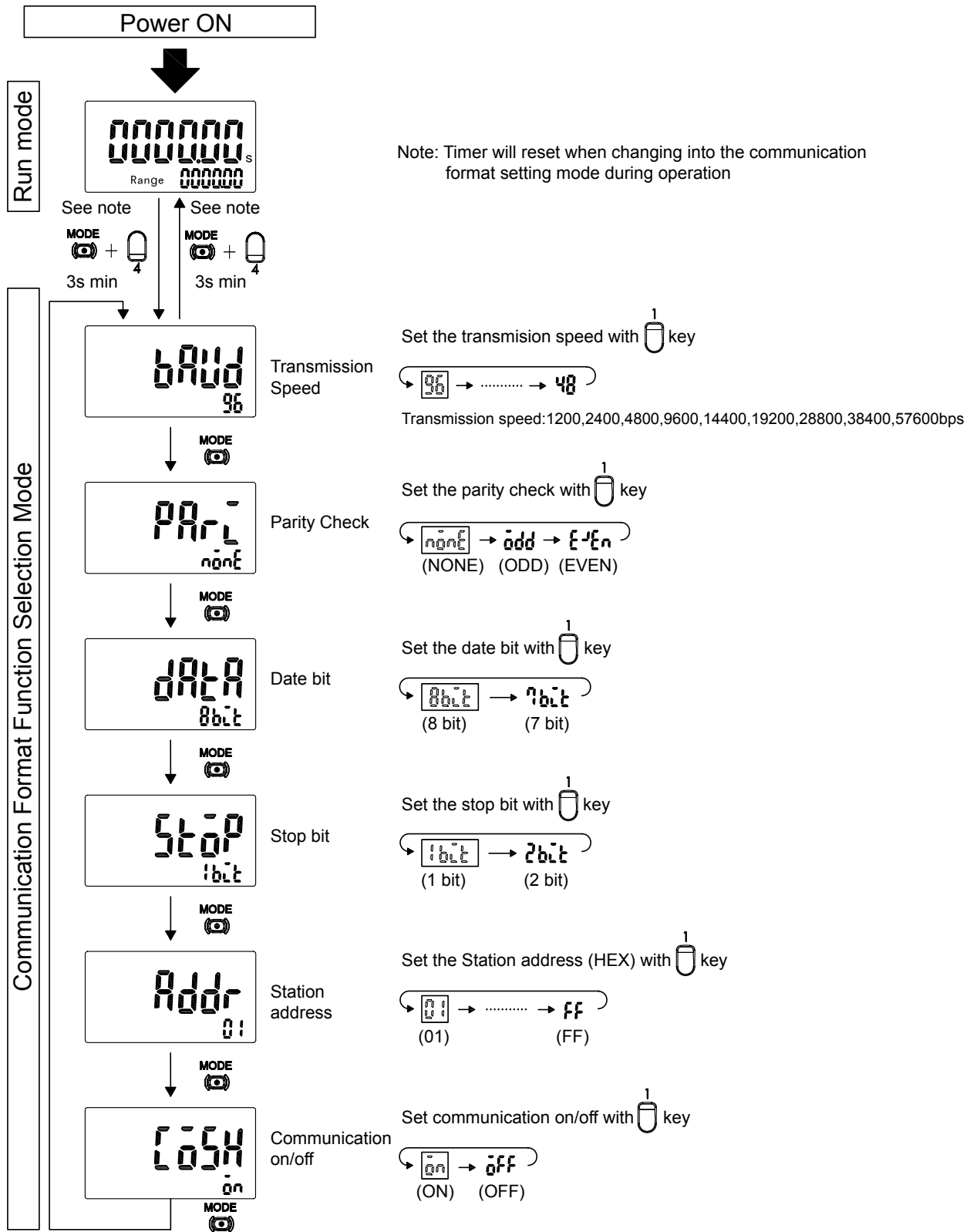

■ Key Protection Setting Mode

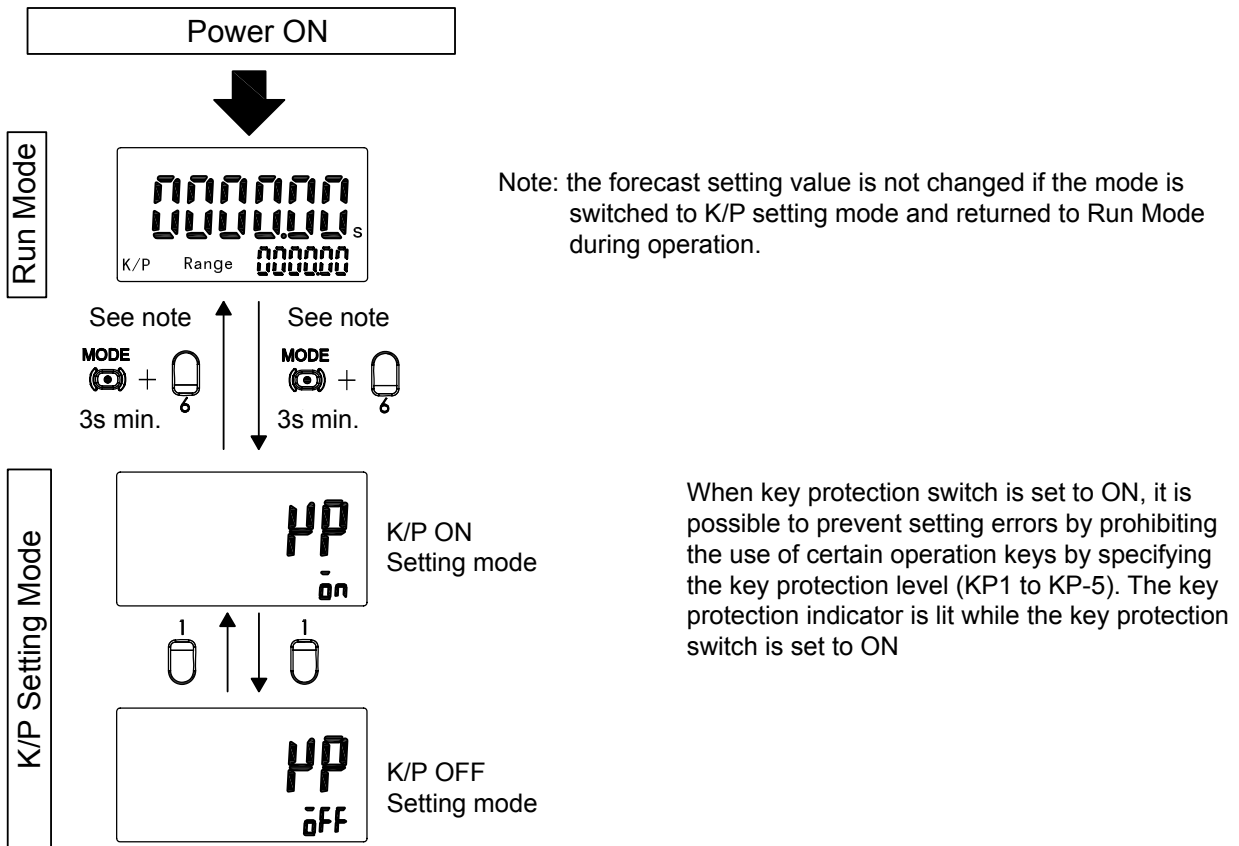

Level	Meaning	Changing mode (see note)	Switching display during operation	Reset key	Up/down key
KP- 1 (default setting)		No	Yes	Yes	Yes
KP- 2		No	Yes	No	Yes
KP- 3		No	Yes	Yes	No
KP- 4		No	Yes	No	No
KP- 5		No	No	No	No

Note: Changing mode to Timer/Twin Timer/2-Stage Timer selection mode (MODE + [2] 3 min.), Communication Format Function Mode (MODE + [4] 3min.), and Basic Function setting (MODE + [4] 3s min.)

Timer Function

Setting for Timer Function

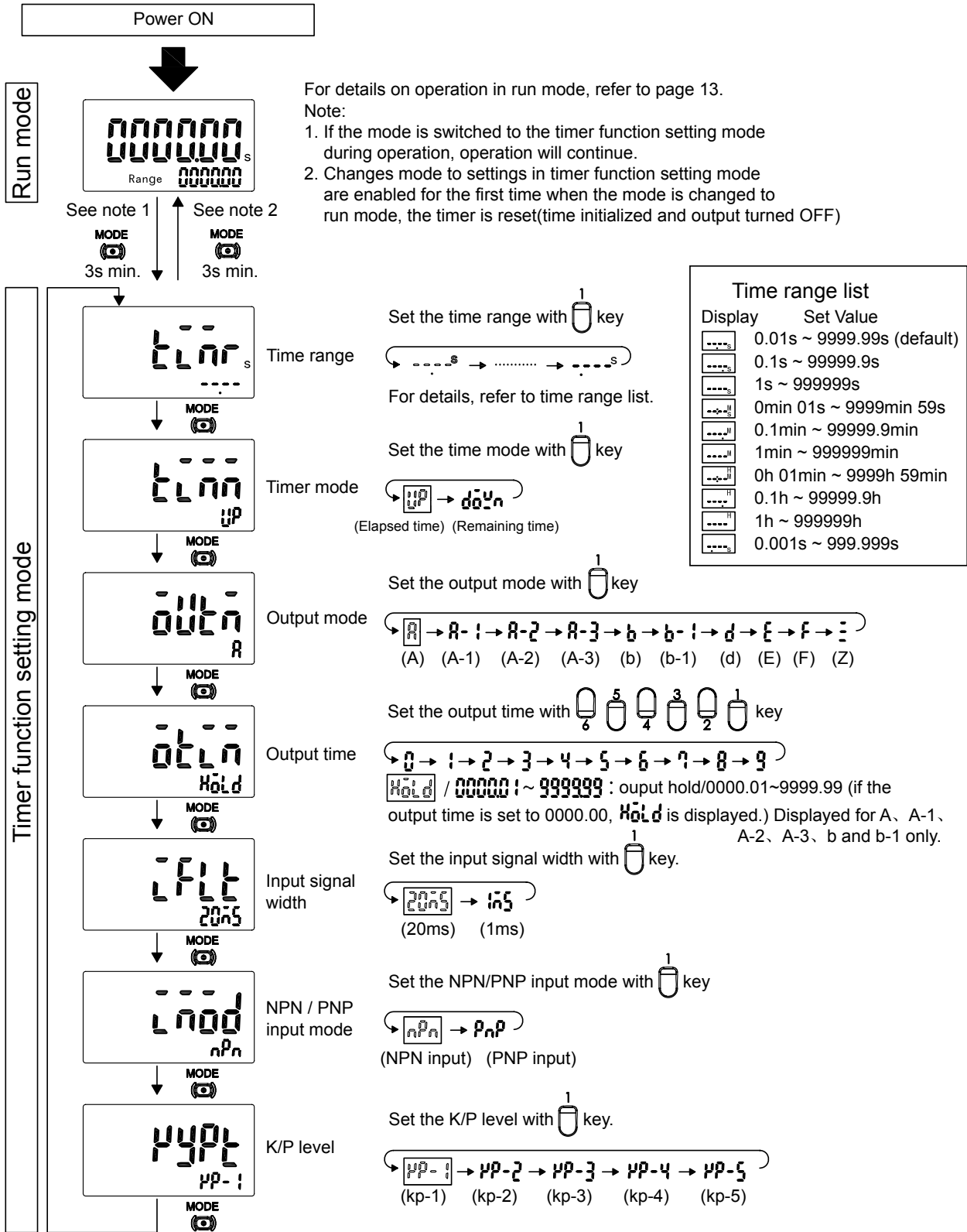

■ Operation in Run Mode

When the output mode is not Z.

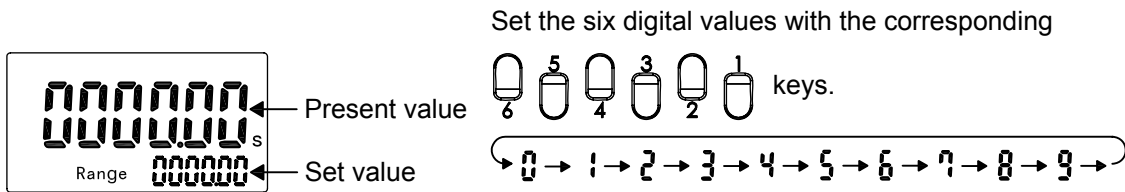

When the output mode is Z.

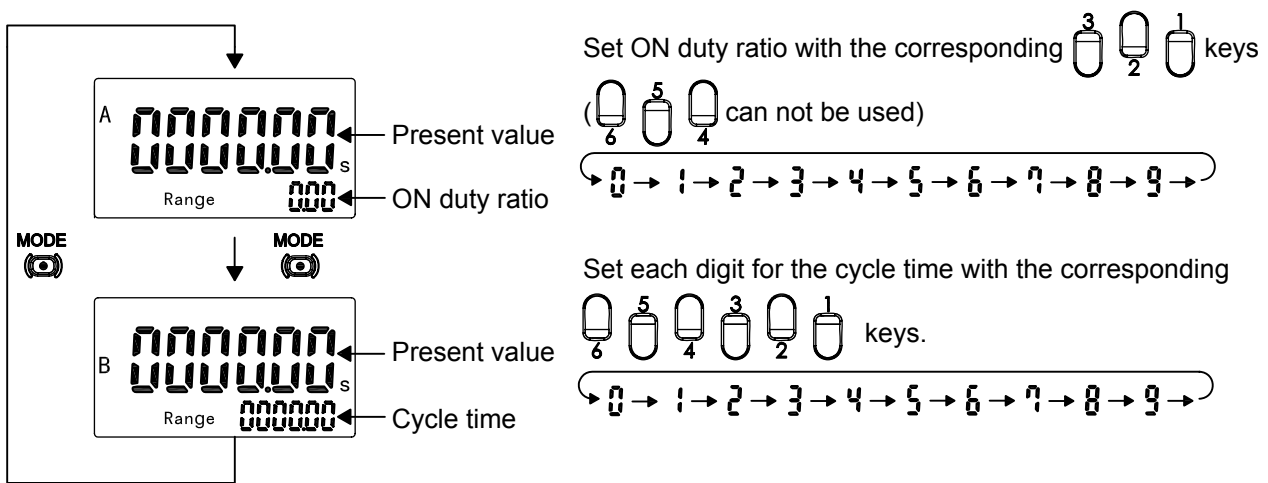

Present value and Set value (output mode≠Z)

These items are displayed when the power is turned ON. The present value is displayed in the main display and the set value is displayed in the sub-display. The values displayed will be determined by the setting mode for the time range and timer mode in function setting mode.

Present value and ON duty ratio (output mode=Z)

The present value is displayed in the main display and the ON duty ratio is displayed in the sub-display. "A" and "Range" light at the same time. Set the ON duty ratio used in ON/OFF duty adjustable flicker mode (Z) as percentage. If a cycle time is set, cycle control can be performed in ON/OFF duty adjustable flicker mode simply by changing the ON duty ratio.

$$\text{ON time} = \text{cycle time} \times \text{ON duty ratio}(\%) / 100$$

Example:

If the cycle time is 30s, the ON duty ratio is 31%, the ON time is given by the following:
 $30(\text{s}) \times 31(\%) / 100 = 9.3(\text{s})$

Present value and Cycle Time (output mode=Z)

The present value is displayed in the main display and the cycle time is displayed in the sub-display. ("B" and "Range" light at the same time.) Set the cycle time used in ON/OFF duty adjustable flicker mode (Z).

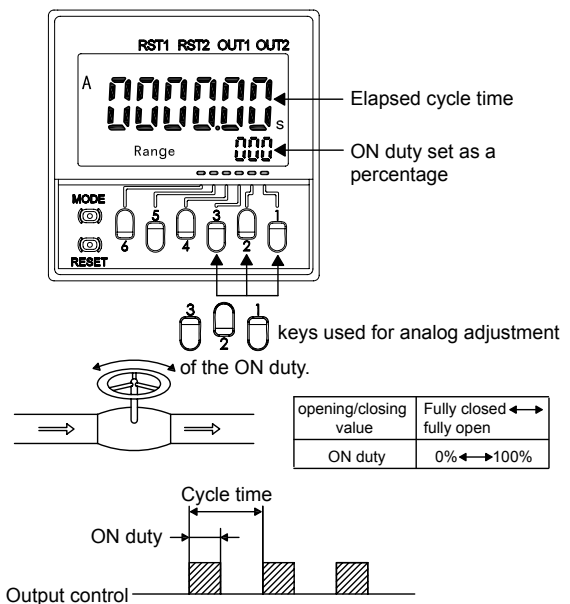

■ Explanation of functions

Time range (timr)

Set the range to be timed in the range 000.000s to 999999h.

Timer Mode (timm)

Set either the elapsed time (UP) or remaining time (DOWN) mode.

Output Mode (outm)

Set the output mode. The possible setting are A、A-1、A-2、A-3、b、b-1、d、E、F and Z.
For details on output mode operation, refer to "timing charts".

Output time (otim)

When using one-shot output, set the output time (0000.01~ 9999.99s).

One-shot output can be used only if the selected output mode A、A-1、A-2、A-3、b or b-1.

If the output time is set to 0000.00s, hold is displayed and the output is held.

Input signal width (iflt)

Set the minimum signal input width (20ms or 1ms) for signal, reset, and gate inputs.

NPN / PNP Input Mode (imod)

Select NPN input (no-voltage input) or PNP (voltage input) as the input format. The same setting is used for all external inputs. For details on input connection, refer to "input connections" on page 46.

Key Protection Level (kypt)

When the key protection switch is ON, it is possible to prevent setting error by prohibiting the use of certain operation keys by specifying K/P level (KP-1 to KP-5). For details, please refer to "Key Protection Setting Mode" on page 11.

Twin Timer Function

■ Twin Timer Function Setting

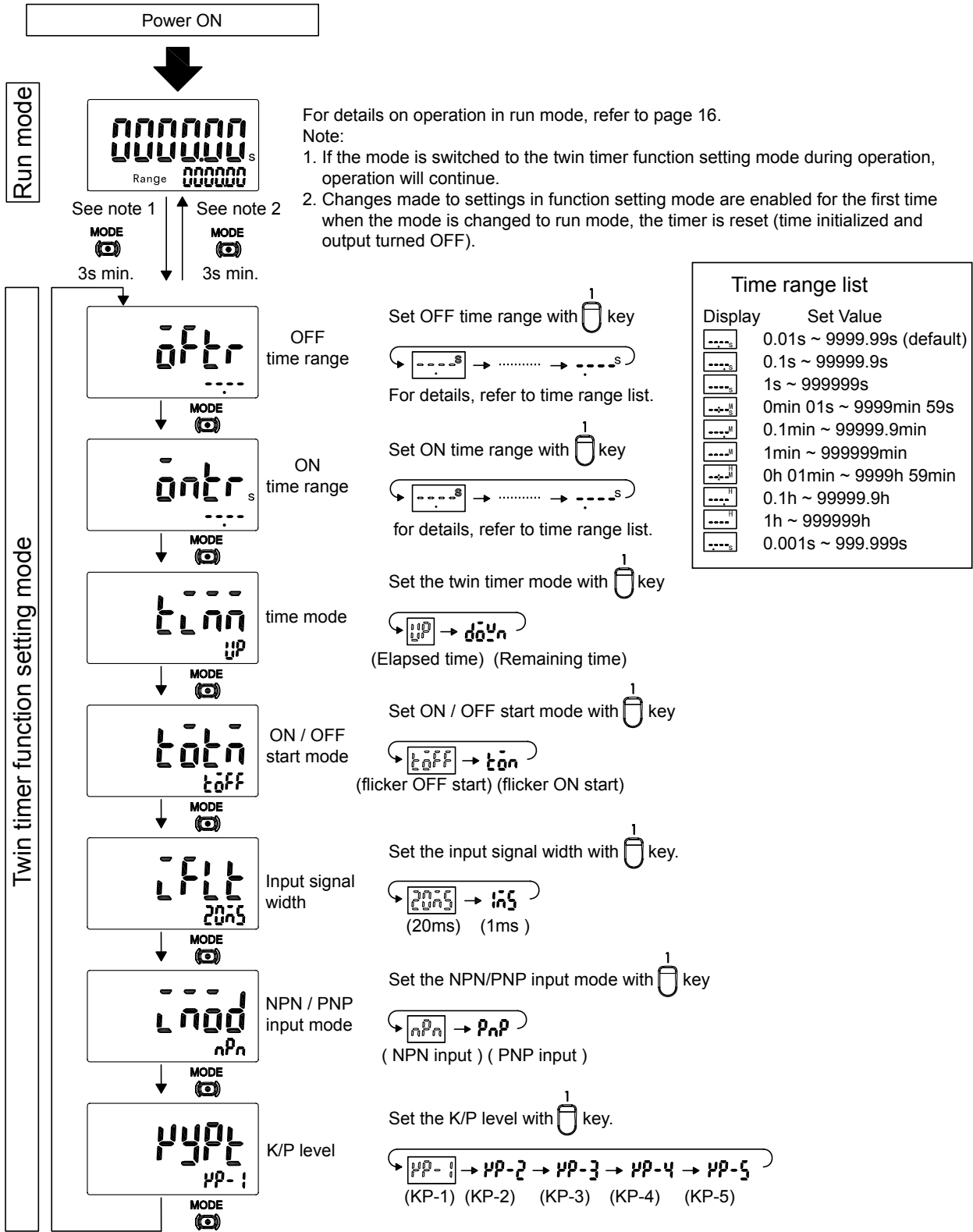

■ Operation in Run Mode

Operation in Run Mode

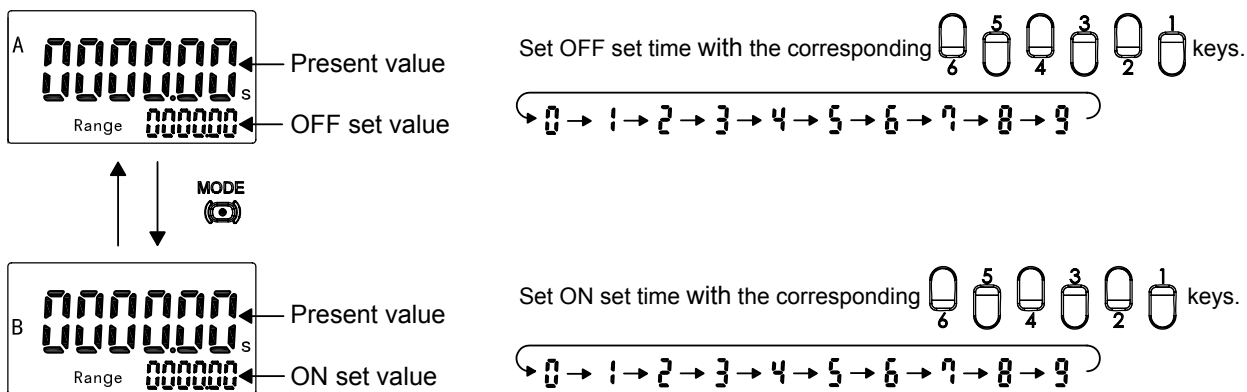

Present value and OFF Set Time

The present value is displayed in the main display and the OFF Set Time is displayed in the sub-display. "A" and "Range" light at the same time.

Present value and ON Set Time

The present value is displayed in the main display and the OFF Set Time is displayed in the sub-display. "B" and "Range" light at the same time.

■ Explanation of functions

OFF Time range (timr)

Set the range to be timed in the range 000.000s to 999999h.

ON Time range (timr)

Set the range to be timed in the range 000.000s to 999999h.

Timer Mode (timm)

Set either the elapsed time (UP) or remaining time (DOWN) mode.

ON/OFF Start Mode (totm)

Set either the flicker OFF start or flicker ON start. For details on start mode, refer to "timing charts".

Input signal width (iflt)

Set the minimum signal input width (20ms or 1ms) for signal, reset, and gate inputs.

NPN / PNP Input Mode (imod)

Select NPN input (no-voltage input) or PNP (voltage input) as the input format. The same setting is used for all external inputs. For details on input connection, refer to "input connections" on page 46.

Key Protection Level (kypt)

When the key protection switch is ON, it is possible to prevent setting error by prohibiting the use of certain operation keys by specifying K/P level (KP-1 to KP-5).

2-Stage Timer Function

2-stage Function Setting

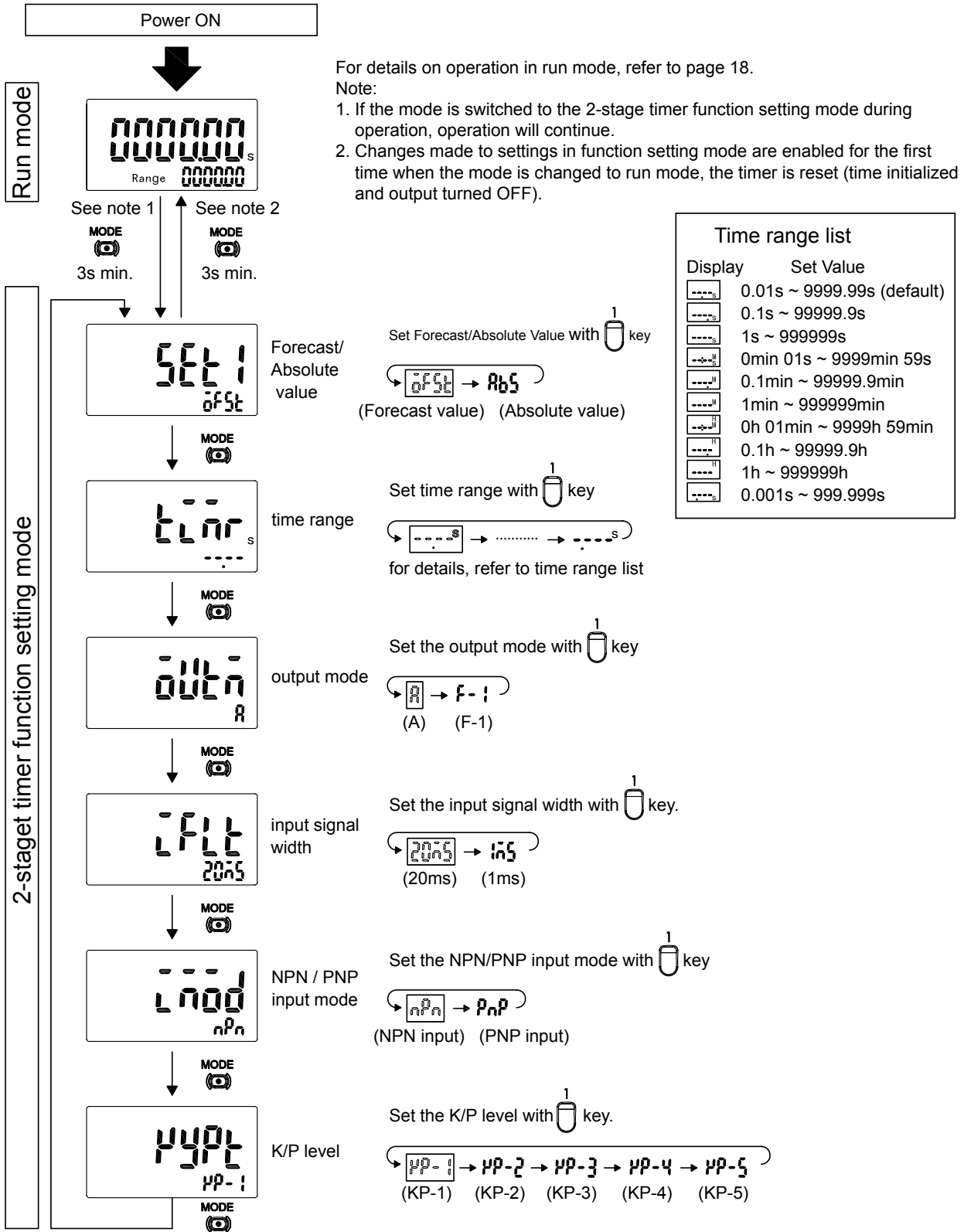

■ Operation in Run Mode

When the forecast value is selected

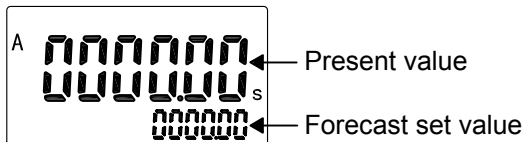
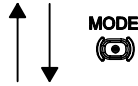
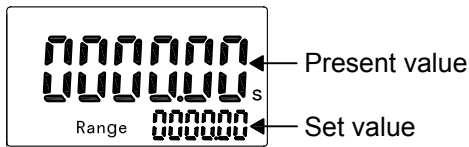

Set "set value" with the corresponding

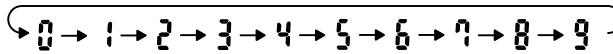

Set "forecast set value" with the corresponding

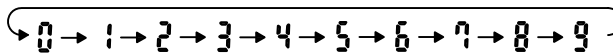

When the absolute value is selected

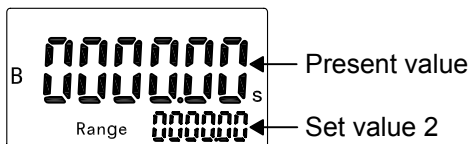
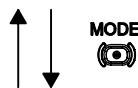
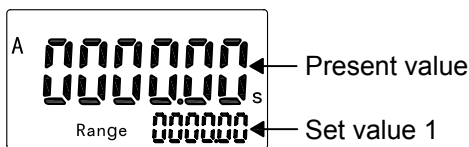

Set "set value 1" with the corresponding

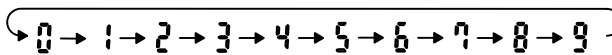

Set "set value 2" with the corresponding

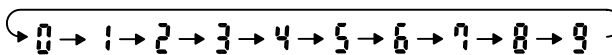

■ Explanation of functions

Forecast / Absolute Value (set1)

For details, refer to the following figure.

Time Range (timr)

Set the range to be timed in the range 000.000s to 999999h.

Output Mode (outm)

Set the output mode. The possible setting are A and F-1

For details on output mode operation, refer to "timing charts".

Input signal width (iflt)

Set the minimum signal input width (20ms or 1ms) for signal, reset, and gate inputs.

NPN / PNP Input Mode (imod)

Select NPN input (no-voltage input) or PNP (voltage input) as the input format. The same setting is used for all external inputs. For details on input connection, refer to "input connections" on page 46.

Key Protection Level (kypt)

When the key protection switch is ON, it is possible to prevent setting error by prohibiting the use of certain operation keys by specifying K/P level (KP-1 to KP-5). For details, refer to "Key Protection Setting Mode" on page 11.

Forecast value Setting

Example: F-1 Mode

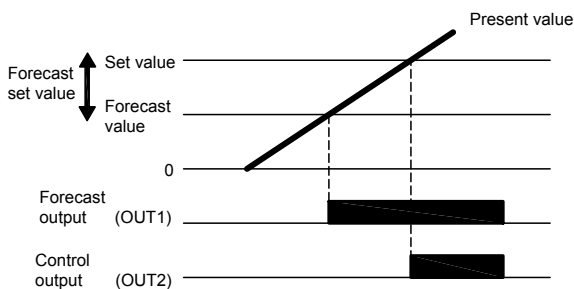

1. OUT1 (forecast output) turns ON when the present value reaches the forecast value.
forecast value = set value - forecast set value
The forecast set value is used to set the deviation for the set value.
2. OUT2 (control output) turns ON when the present value reaches the set value.
3. If the forecast set value \geq set value, OUT1 (forecast output) turns ON as soon as timing starts.

Absolute value Setting

Example: F-1 Mode

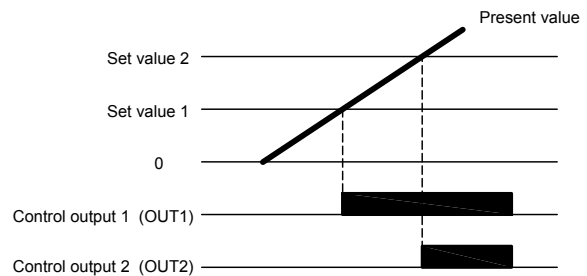

1. OUT1 (control output 1) turns ON when the present value reaches the set value 1.
2. OUT2 (control output 2) turns ON when the present value reaches the set value 2.

Counter Function

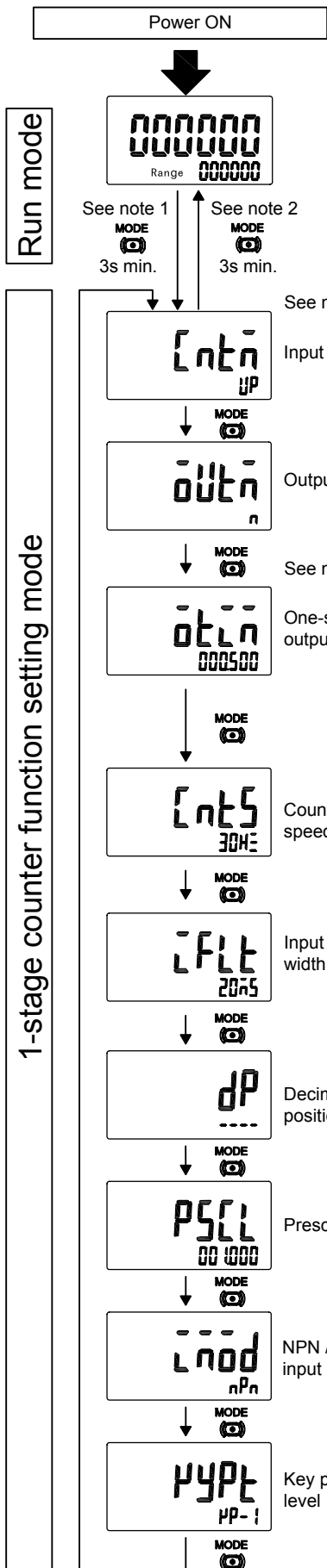

For details on operation in run mode, refer to page23.

Note:

1. If the mode is switched to counter function setting mode during operation, operation will continue.
2. Changes made to settings in function setting mode are enabled for the first time when the mode is changed to run mode, the counter is reset(the preset value is initialized and output turned OFF).

(See note 3) when using as a dual counter:

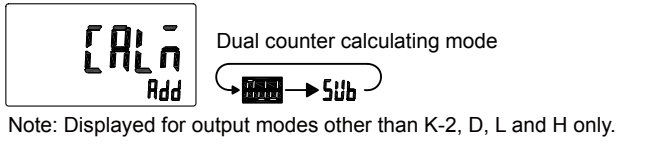

Note: displayed for output modes other than K-2, D, L and H only.

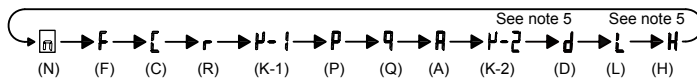

Note 5: displayed only when the input mode is UP/DOWN A, B or C.

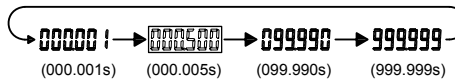

Note: Displayed only when the output mode is C, R, K-1, P, Q, A or K-2.

(See note 6) when using as a 2-stage counter :

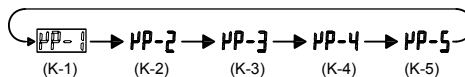
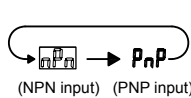
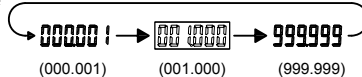
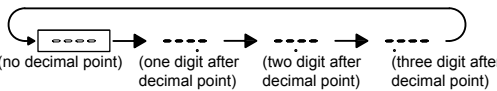
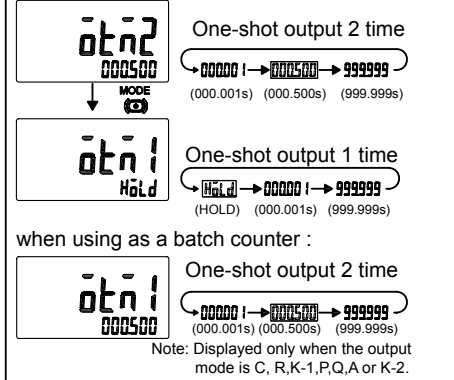

■ Explanation of functions

Input mode (cntm)

Set increment mode(UP)、decrement mode (DOWN)、or increment/ decrement mode (UP/DOWN A、UP/DOWN B、UP/DOWN C) as the input mode.

Dual count calculating mode (calm)

When using a dual counter, select ADD (addition) or SUB (subtraction) as the calculation method for the dual count value. SUB mode can be used only when K-2, D, L or H is selected as the output mode with 6-digit models.

ADD: Dual count value=CP1 PV+CP2 PV

SUB: Dual count value =CP1 PV-CP2 PV

Output mode (outm)

Set the way that control output for the present value is output. The possible settings are N,F,C,R,K-1,P,Q,A,K-2,D,L and H.

One-shot output 2 time (otm2)

Set one-shot output time for control output (OUT2) when using as a 2-stage counter or batch counter. (000.001 to 999.999)One-shot output can be used only when C, R, K-1, P, Q, A or K-2 is selected as the output mode.

One-shot output 1 time (otm1)

Set one-shot output time (000.001 to 999.999) for control output (OUT1) when using as 2-stage counter. One-shot output can be used only when D, L or H is selected as the output mode. If the output time is set to 0.00, HOLD is displayed, and outputs are held. HOLD can not be set when the output mode is K-2.

Counting speed (cnts)

Set the maximum counting speed (30Hz/5KHz) for CP1 and CP2 inputs together. If contacts are used for input signal, set the counting speed to 30Hz. Processing to eliminate chattering is performed for this setting.

Input signal width (iflt)

Set Reset input signal width (20ms/1ms) for reset/ reset1 and total reset/reset2 inputs together. If contacts are used for input signals, set the counting speed to 20ms. Processing to eliminate chattering is performed for this setting.

Decimal point position (dp)

Decide the decimal point position for the present value, CP1/CP2 present values, set value (SV1, SV2), total count value and dual count set value.

Prescale value (pscl)

Pulses input to the counter are converted according to the specified prescale value. (Setting range: 0.001~99.999)

Example: To display the feed distance for systems that output 25 pulses for a feed length of 0.5m in the form □□.□□m:



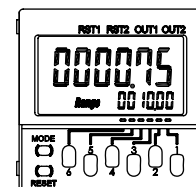
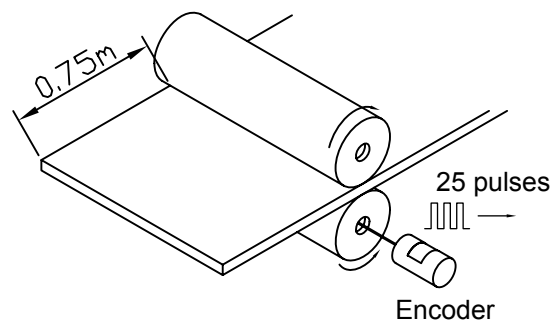



1. Set the decimal point position to 2 decimal places
2. Set the prescale value to 0.03



NPN/PNP input mode (imod)

Select either NPN input (no-voltage input) or PNP input (voltage input) as the input format. The same setting is used for all external inputs.

■ Operation in Run Mode

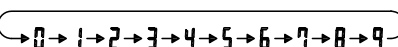
Set values for each digit as required with the       keys. 

1-stage Counter

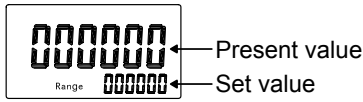

Present value: Shows present count value
 Set value (Set value 1, 2): Set the set value.
 When the present value reaches the set value, signals are output according to the specified output mode.

2-stage Counter

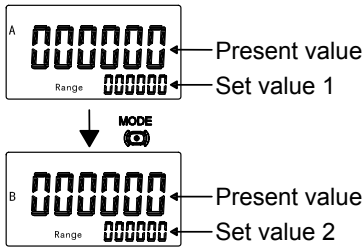

Total counter

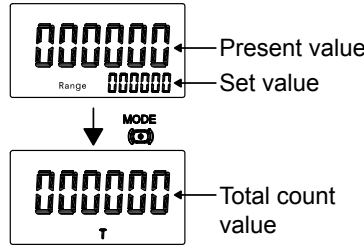

Present value/ Set value:
 Same as 1-stage counter

Total count value:
 Shows the present total count value

Batch Counter

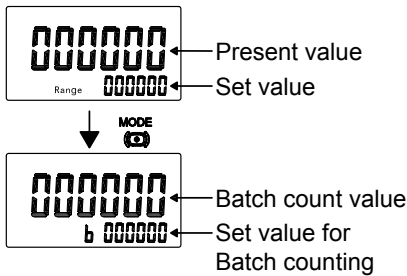

Present value/ Set value:
 Same as 1-stage counter

Batch count value: shows the number of times the count has been completed for the present value.
 Batch count set value: set the batch count set value. When batch count value reaches the batch count set value, batch output (OUT1) turns ON.

Dual Counter

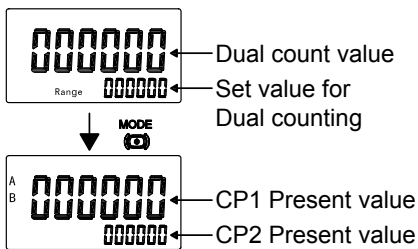

Dual count value:
 Shows the sum of the CP1 present value and the CP2 present value when the dual count calculating mode is ADD and shows the value obtained by subtracting the CP2 present value from the CP1 present value when the dual count calculating mode is SUB.

Dual count set value:
 Set dual count set value. When the dual count value reaches the dual count set value, signals are output according to the specified output mode.

CP1/ CP2 present value:
 Show the present count values for CP1 and CP2 present values respectively.

Tachometer Function

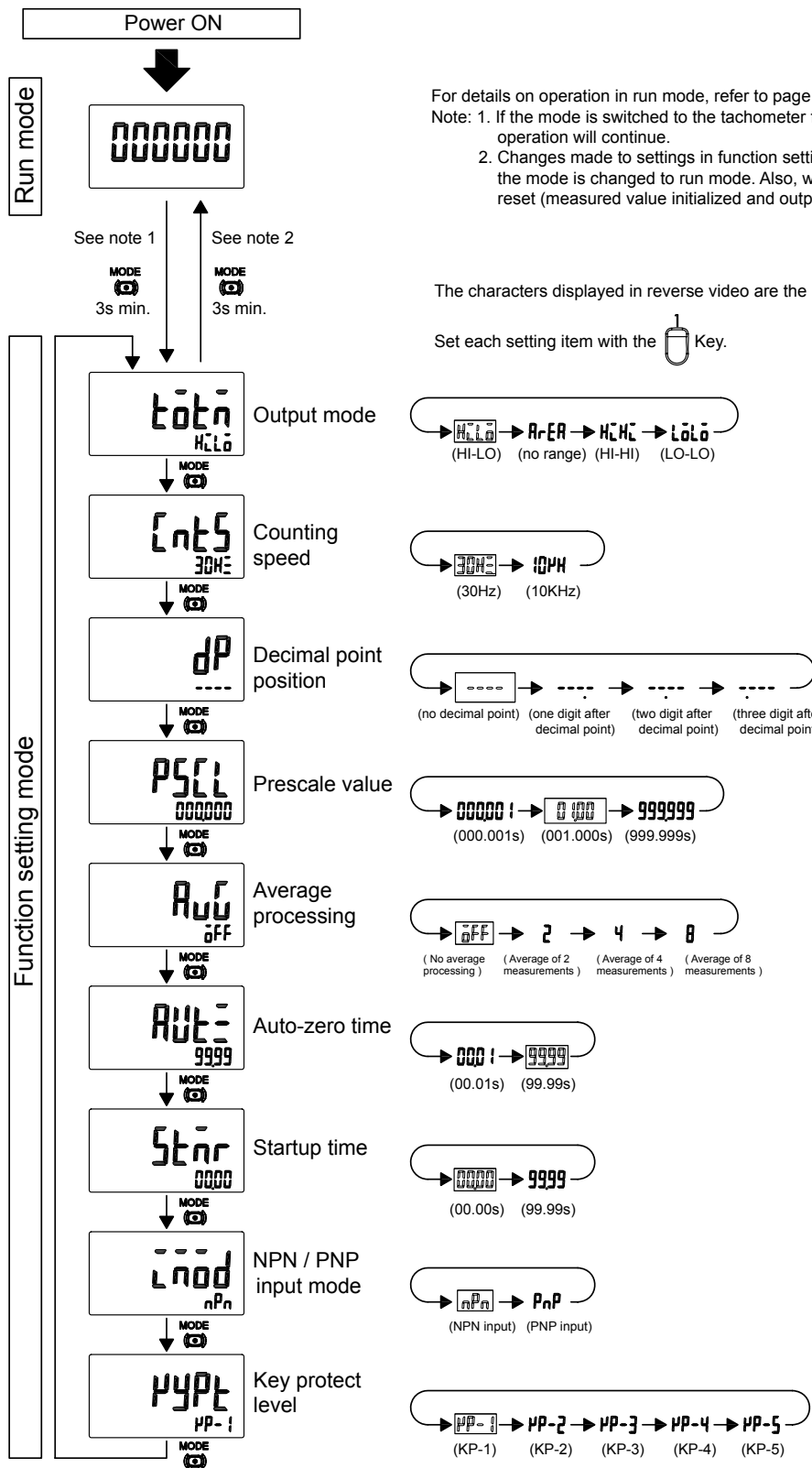

For details on operation in run mode, refer to page 25.

Note: 1. If the mode is switched to the tachometer function setting mode during operation, operation will continue.

2. Changes made to settings in function setting mode are enabled for the first time when the mode is changed to run mode. Also, when settings are changed, the counter is reset (measured value initialized and output turned OFF) on returning to run mode.

The characters displayed in reverse video are the initial values.

Set each setting item with the Key.

■ Explanation of Tachometer Functions

Tachometer output mode (totm)

Set the output method for control output based on the OUT1/OUT2 set value. Upper and lower limit (HI-LO), area (AREA), upper (HI-HI), and lower limit (LO-LO) can be set.

Counting speed (cnts)

Set the maximum counting speed (30Hz/10KHz) for CP1 input. If contacts are used for input signals, set the counting speed to 30Hz. Processing to eliminate chattering is performed for this setting.

Decimal point position (dp)

Decide the decimal point position for the measurement value, OUT1 set value, and OUT2 set value.

Prescale value (pscl)

It is possible to display the rate of rotation or the speed of a device or machine to which the TC-Pro482 is mounted by converting input pulses to a desired unit. If this prescaling function is not used, the input frequency (Hz) will be displayed. The relationship between display and input is determined by the following equation. Set the prescale value according to the unit to be displayed. Displayed value=input pulse frequency×prescale value

1. Displaying rotation rate

Display unit	Prescale value
rpm	1/N*60
rps	1/N

N: number of pulses per revolution

Example: in order to display the rate of rotation for a machine that outputs 10 pulses per revolution in the form □□□.□□□rpm:

1. Set the decimal point position to 3 decimal place
2. Using the formula, set the prescale value to 6

2. Displaying speed

Display unit	Prescale value
m/min	$\pi d * 1/N * 60$
m/s	$\pi d * 1/N$

N: number of pulses per revolution

d: diameter of rotating body

πd : circumference

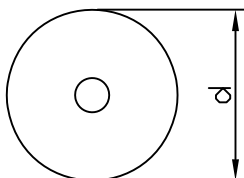

Average processing (aug)

Flickering display and output chattering can be prevented using average processing (simple averaging). Average processing can be set to one of four levels: no average processing, 2 times (i.e., the average of 2 measurement values), 4 times, 8 times. The measurement cycle will be equal to the sampling cycle (100ms) multiplied by the average processing setting (i.e., the number of time). Average processing enables fluctuating input signals to be displayed stably. Set the optimum number of times for the application.

Auto-zero time (autz)

It is possible to set the TC-Pro482 so that if there is no pulse for a certain time the display is force-set to 0. This time is called the auto-zero time. Set the auto-zero time to a time slightly longer than the estimated interval between input pulses and within the setting range (00.01~99.99s). It will not be possible to make accurate measurements if the auto-zero time is set to a time shorter than the input pulse cycle. Setting a time that is too long may also result in problems, such as a time-lag between rotation stopping and the alarm turning ON.

Startup time (stmr)

In order to prevent undesired output resulting from unstable input immediately after the power supply is turned ON, it is possible to prohibit measurement for a set time (00.00~99.99s), the startup time. It can also be used to stop measurement and disable output until the rotating body reaches the normal rate of rotation, after the power supply to the TC-Pro482 and rotating body are turned ON at the same time.

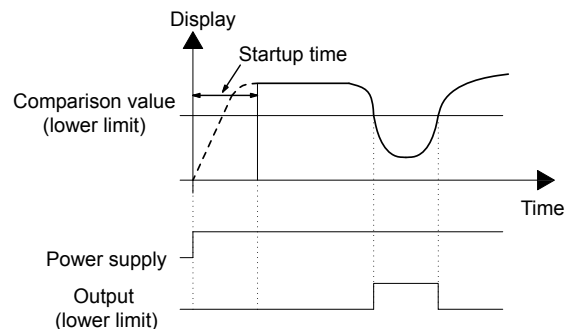

NPN/PNP input mode (imod)

Select either NPN input (no-voltage input) or PNP input (voltage input) as the input format. The same setting is used for all external inputs.

■ Operation in Run Mode

Set values for each digit as required with the $\frac{5}{6}$ $\frac{3}{4}$ $\frac{1}{2}$ keys. $\rightarrow 0 \rightarrow 1 \rightarrow 2 \rightarrow 3 \rightarrow 4 \rightarrow 5 \rightarrow 6 \rightarrow 7 \rightarrow 8 \rightarrow 9$

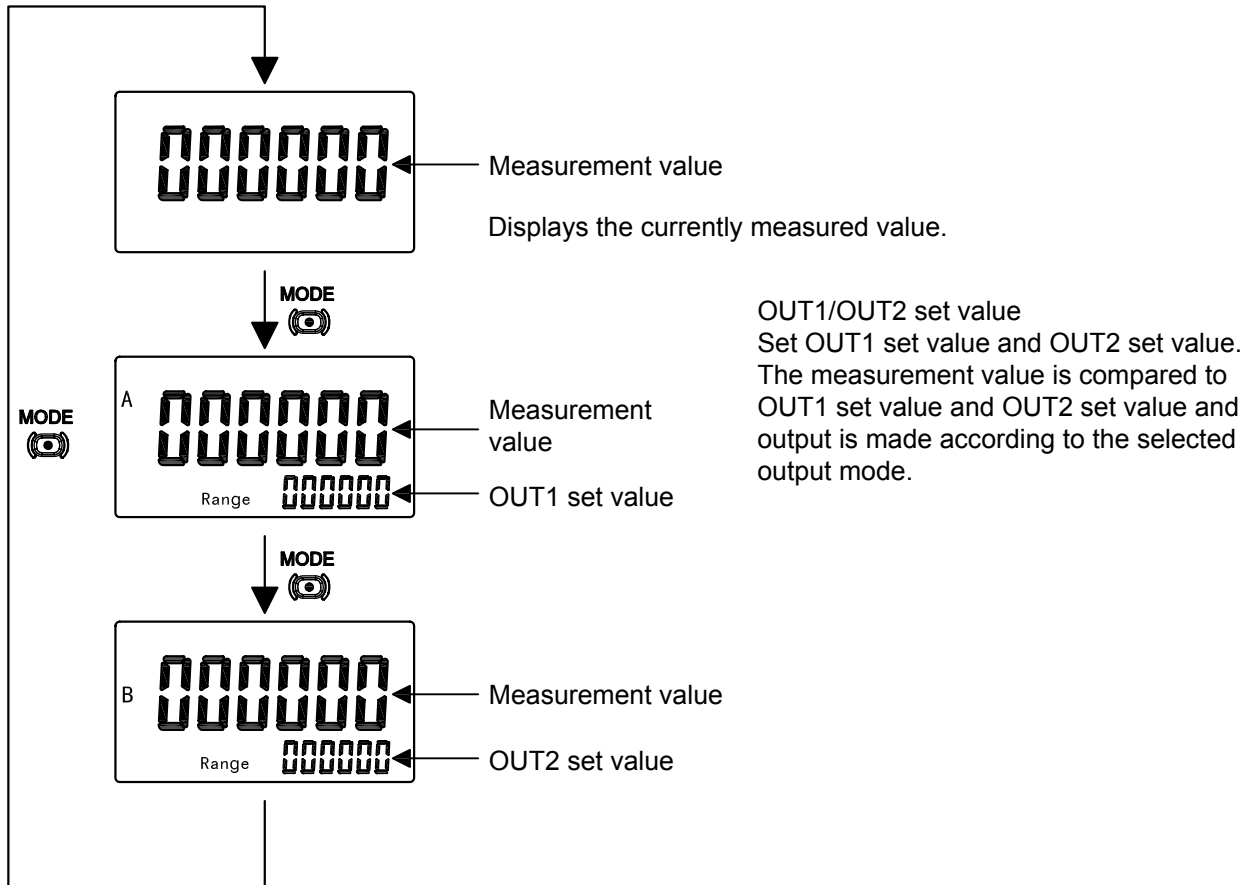

Sequence Charts

■ Timer Operation

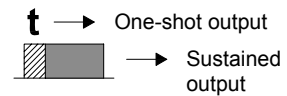

Either one-shot output or sustained output can be selected

Output mode A: signal ON delay 1 (timer resets when power comes ON)	
	<p>Timing starts when the start signal goes ON. While the start signal is ON, the timer starts when the power comes ON or when the reset input goes OFF. The control output is controlled using a sustained or one-shot time period.</p> <p>Basic Operation</p> <p>Output is instantaneous when setting is 0. Start signal input is disabled during timing.</p>
Output mode A-1: signal ON delay 2 (timer resets when power comes ON)	
	<p>Timing starts when the start signal goes ON, and is reset when the start signal goes OFF. While the start signal is ON, the timer starts when the power comes ON or when the reset input goes OFF. The control output is controlled using a sustained or one-shot time period.</p> <p>Basic Operation</p> <p>Output is instantaneous when setting is 0.</p>
Output mode A-2: Power ON delay 1 (timer resets when power comes ON)	
	<p>Timing starts when the reset signal goes OFF. The start signal disables the timing function (i.e., same function as the gate input). The control output is controlled using a sustained or one-shot time period.</p> <p>Basic Operation</p> <p>Output is instantaneous when setting is 0.</p>
Output mode A-3: Power ON delay 2 (timer does not reset when power comes ON)	
	<p>Timing starts when the reset signal goes OFF. The start signal disables the timing function (i.e., same function as the gate input). The control output is controlled using a sustained or one-shot time period.</p> <p>Basic Operation</p> <p>Output is instantaneous when setting is 0.</p>

Output mode b: Repeat cycle 1 (timer resets when power comes ON)

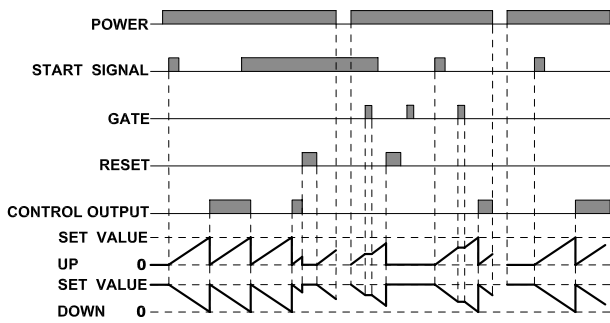

Timing starts when the start signal goes ON.
 The status of the control output is reversed when time is up (OFF at start).
 While the start signal is ON, the timer starts when the power comes ON or when the reset input goes OFF.

Basic Operation

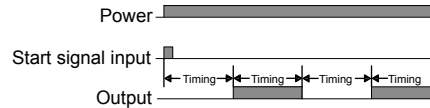

Normal output operation will not be possible if the set time is too short.
 Set the value to at least 100ms (contact output type).
 Start signal input is disabled during timing.

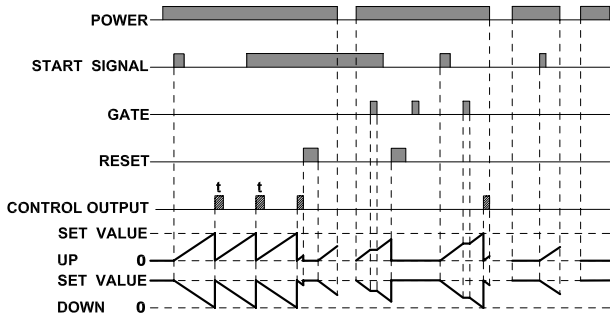

Timing starts when the start signal goes ON.
 The status of the control output is turned ON when time is up.
 While the start signal is ON, the timer starts when the power comes ON or when the reset input goes OFF.

Basic Operation

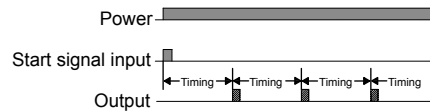

Normal output operation will not be possible if the set time is too short.
 Set the value to at least 100ms (contact output type).
 Start signal input is disabled during timing.

Output mode b-1: Repeat cycle 2 (timer does not reset when power comes ON)

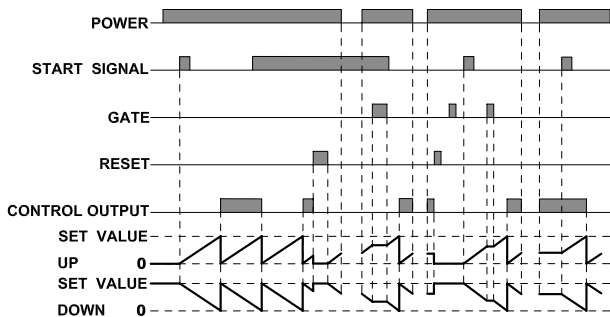

Timing starts when the start signal goes ON.
 The status of the control output is reversed when time is up (OFF at start).
 While the start signal is ON, the timer starts when the power comes ON or when the reset input goes OFF.

Basic Operation

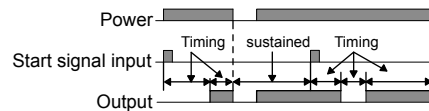

Normal output operation will not be possible if the set time is too short.
 Set the value to at least 100ms (contact output type).
 Start signal input is disabled during timing.

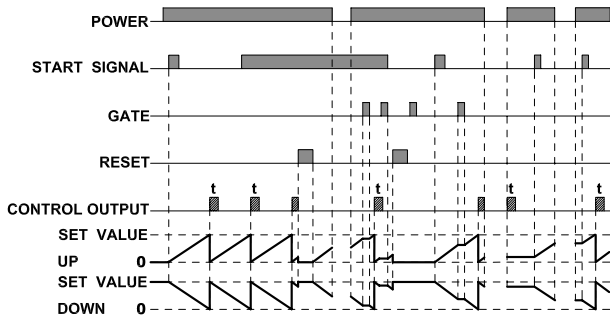

Timing starts when the start signal goes ON.
 The status of the control output is reversed when time is up (OFF at start).
 While the start signal is ON, the timer starts when the power comes ON or when the reset input goes OFF.

Basic Operation

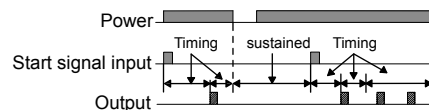

Normal output operation will not be possible if the set time is too short.
 Set the value to at least 100ms (contact output type).
 Start signal input is disabled during timing.

Output mode d: Signal OFF delay (Timer resets when power comes ON.)	
	<p>The control output is ON when the start signal is ON (except when the power is OFF or the reset is ON.) The timer is reset when the time is up.</p> <p style="text-align: center;">Basic Operation</p> <p>Output functions only during start signal input when setting is 0. Start signal input is disabled during timing.</p>
Output mode E: Interval (timer resets when power comes ON)	
	<p>Timing starts when the start signal comes ON. The control output is reset when time is up. While the start signal is ON, the timer starts when power comes ON or when the reset input goes OFF.</p> <p style="text-align: center;">Basic Operation</p> <p>Instantaneous output is disabled when setting is 0.</p>
Output mode F: Cumulative (timer does not reset when power comes ON.)	
	<p>Timing is enabled by start signal (timing is stopped when the start signal is OFF or when the power is OFF). A sustained control output is used.</p> <p style="text-align: center;">Basic Operation</p> <p>Output is instantaneous when setting is 0.</p>
Z mode : ON/OFF - duty adjustable flicker	
	<p>Timing starts when the reset signal goes ON. The status of the control output is reversed when time is up (ON at start). While the start signal is ON, the timer starts when the power comes ON or when the reset input goes OFF.</p> <p style="text-align: center;">Basic Operation</p> <p>Normal output operation will not be possible if the set time is too short. Set the value to at least 100ms (contact output type). Start signal input is disabled during timing.</p>

Z mode:

Output quantity can be adjusted by changing the cycle time set in the adjustment level to 1 and by changing the ON duty (%) set value.

Set value shows the ON duty(%) and can be set to a value between 0 and 100 (%). When the cycle time is 0, the output will always be OFF.

When the cycle time is not 0 and when ON duty has been set to 0(%), the output will always be OFF. When ON duty has been set to 100 (%), the output will always be ON.

■ Twin Timer Operation

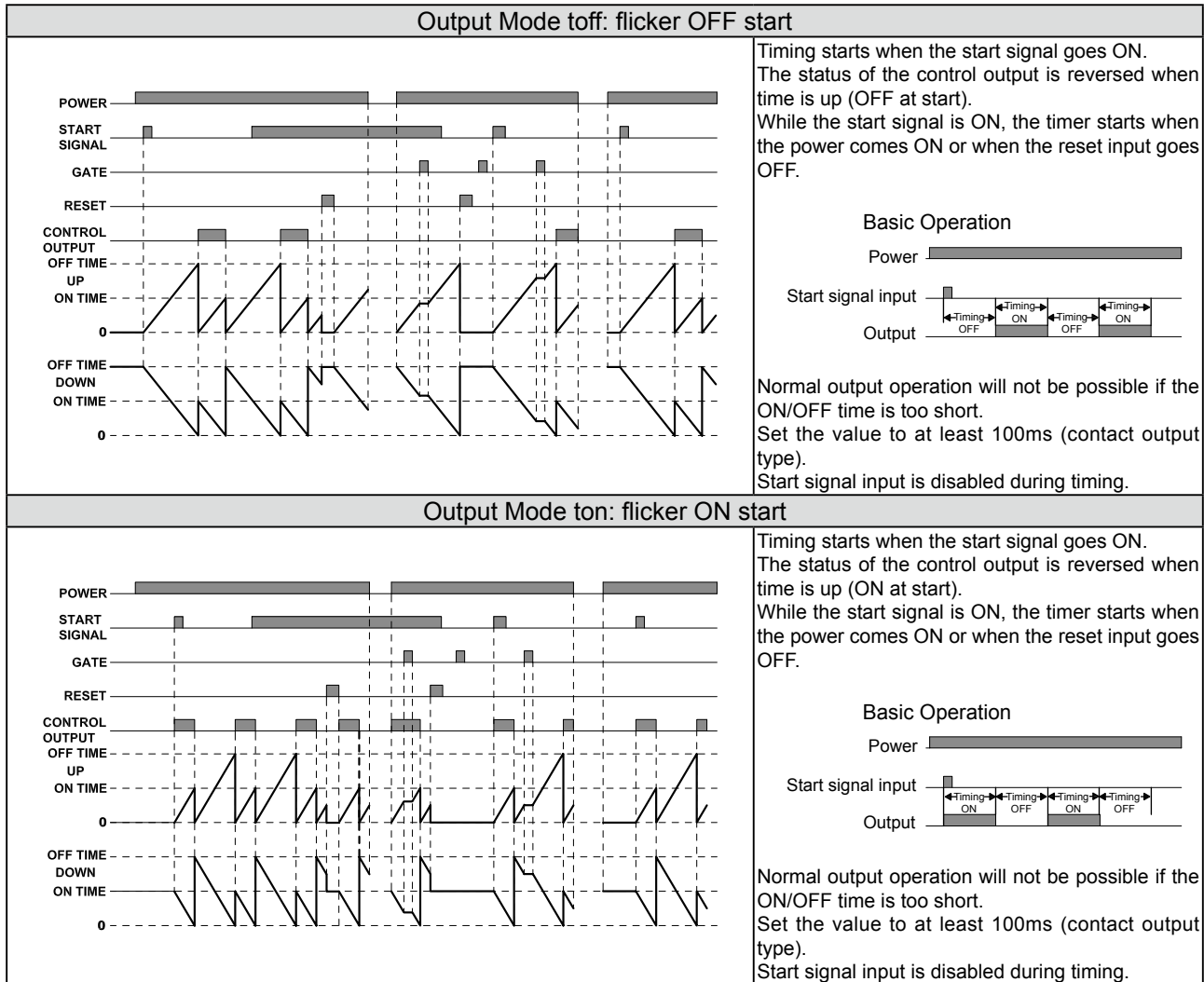

■ 2-Stage Timer Operation

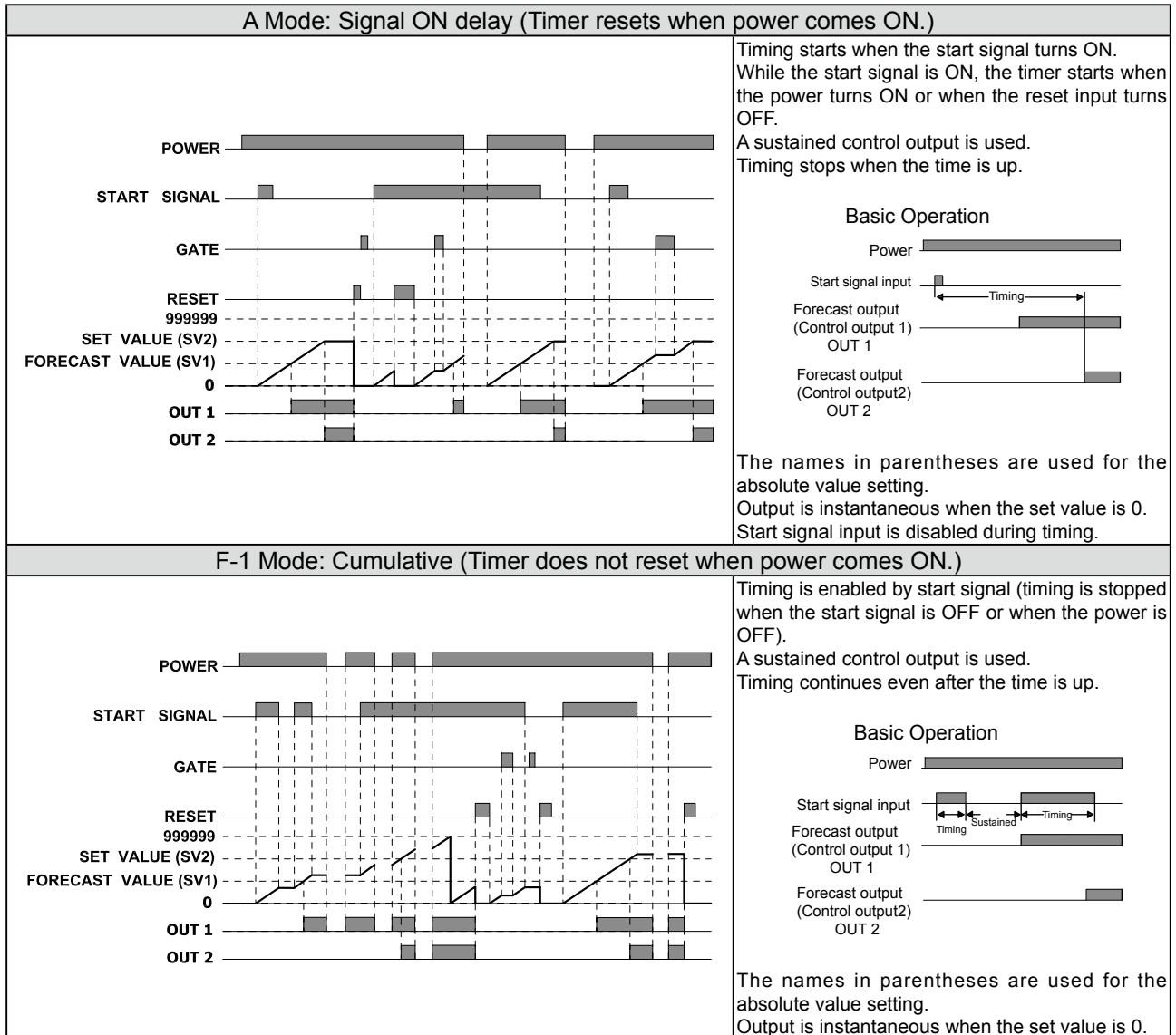

Input Modes and Present Value (Counter)

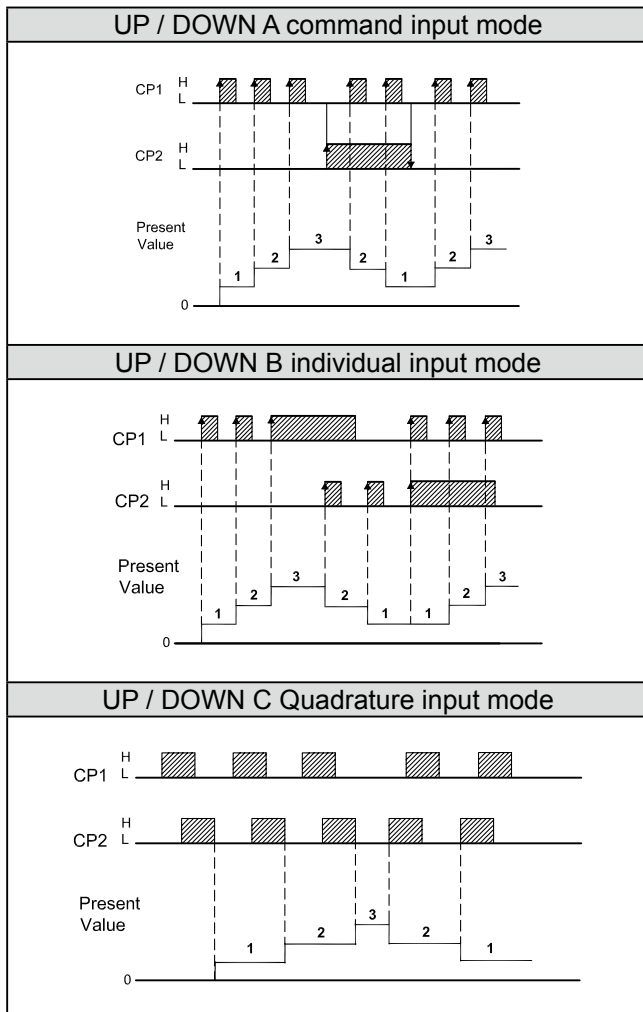
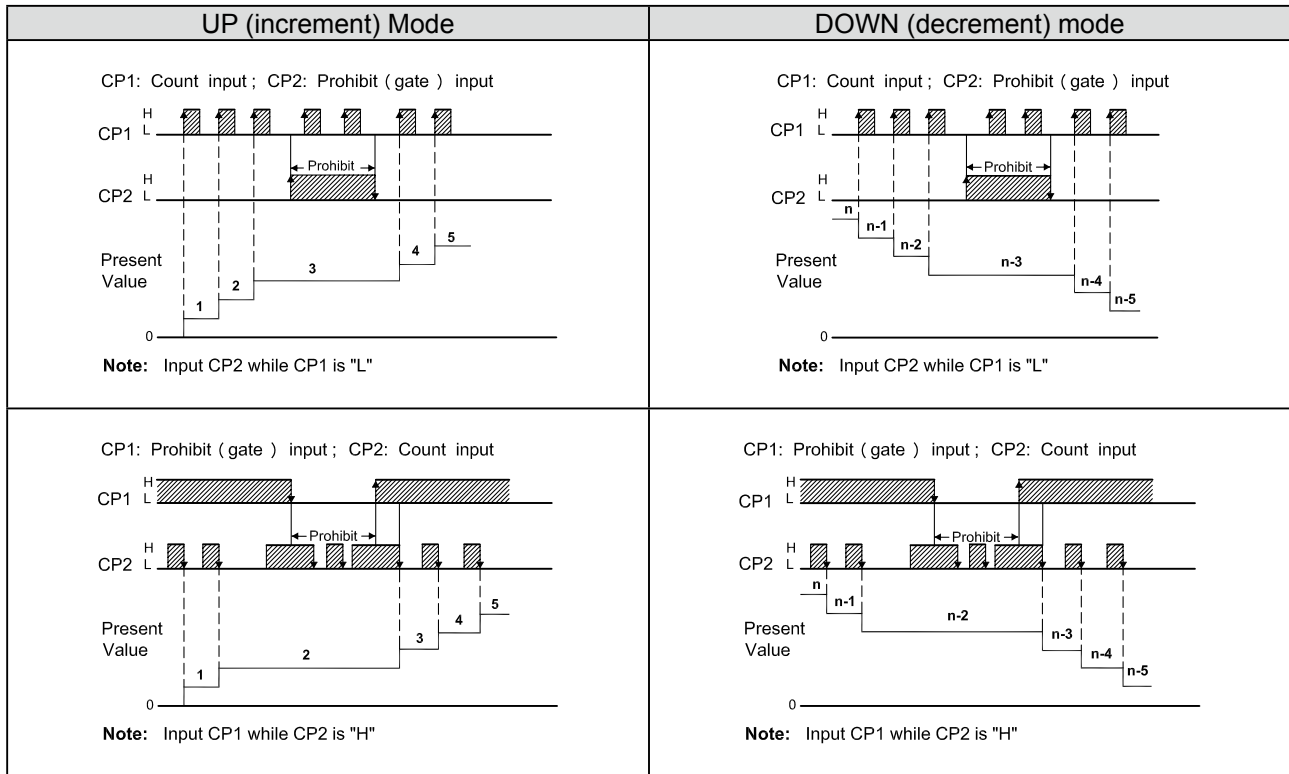

Note:

1. If the configuration selection is set to dual count, CP1 and CP2 input will operate in the same way as the count input (CP1) of UP (increment) mode.
2. The meaning of the H and L symbols in the tables is explained below.

Input method symbol	No-voltage (NPN input)	Voltage input (PNP input)
H	Short-circuit	4.5~30VDC
L	OPEN	0~2VDC

Input/Output Mode Setting(Counter)

Operation for 1-stage models is the same as that for OUT2.

When using a 2-stage model as a 1-stage counter, or dual counter, total counter, OUT1 and OUT2 turn ON and OFF simultaneously.

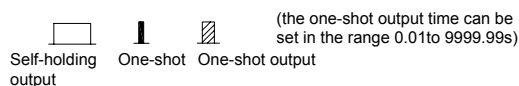

		Output mode			Operation after count completion
		UP	DOWN	UP/DOWN A, B, C	
Output mode setting	N				The outputs and present value display are held until reset/reset1 is input.
	F				The present value display continues to increase/decrease. The outputs are held until reset/reset1 is input.
	C				As soon as the count value reaches SV, the present value display returns to the reset start status. The present value display does not show the present value upon count-up. The outputs repeat one-shot operation. OUT1 self-holding output turns OFF after the OUT2 one-shot output time. The OUT1 one-shot output time is independent of OUT2.
	R				The present value display returns to the reset start status after the one-shot output time. OUT1 self-holding output turns OFF after the OUT2 one-shot output time. The OUT1 one-shot output time is independent of OUT2.

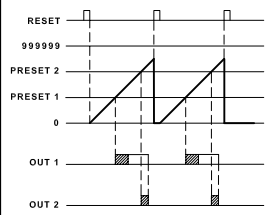
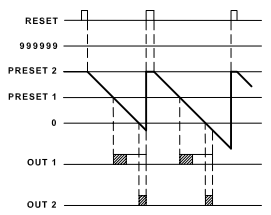
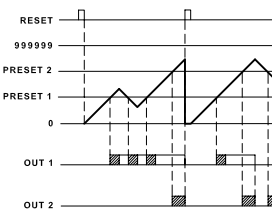
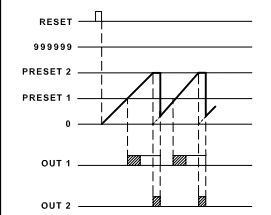
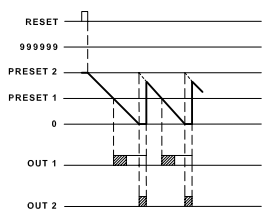
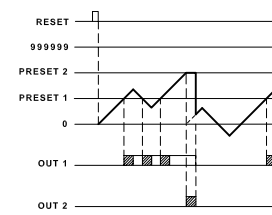
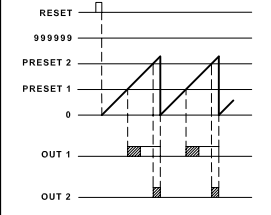
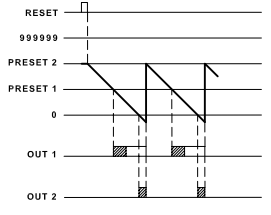
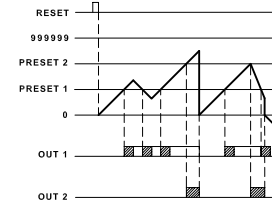
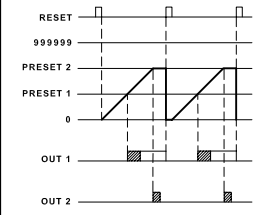
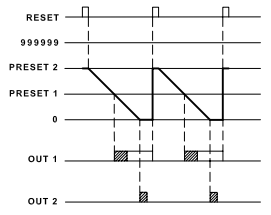
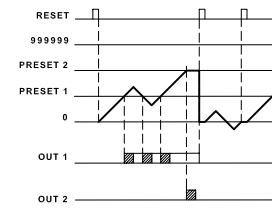

Note:

1. The full scale (FS) for TC-Pro 6-digit models is 999999.
2. When the present value reaches 999999, it returns to 0.
3. Counting can not be performed during reset/reset1 input.
4. If reset/reset1 is input while one-shot output is ON, one-shot output turns OFF.
5. Do not use the counter function in applications where the count may be completed (again) while one-shot output is ON.

		Output mode			
		UP	DOWN	UP/DOWN A, B, C	Operation after count completion
Output mode setting	K-1				The present value display continues to increase/decrease. OUT1 self-holding output turns OFF after the OUT2 one-shot output time. The OUT1 one-shot output time is independent of OUT2.
	P				The present value display does not change during the one-shot output time, but the actual count returns to the reset status. The outputs return to the one-shot start state and repeat one-shot operation. OUT1 self-holding output turns OFF after the OUT2 one-shot output time. The OUT1 one-shot output time is independent of OUT2.
	Q				The present value continues to increase/decrease for the one-shot output time, but returns to the reset start status after the one-shot output time has elapsed. The outputs repeat one-shot operation. OUT1 self-holding output turns OFF after the OUT2 one-shot output time. The OUT1 one-shot output time is independent of OUT2.
	A				The present value display and OUT1 self-holding output is held until reset/reset1 is input. OUT1 and OUT2 are independent.

Note:

1. The full scale (FS) for TC-Pro 6-digit models is 999999.
2. When the present value reaches 999999, it returns to 0.
3. Counting can not be performed during reset/reset1 input.
4. If reset/reset1 is input while one-shot output is ON, one-shot output turns OFF.
5. Do not use the counter function in applications where the count may be completed (again) while one-shot output is ON.

 Self-holding output
  One-shot
  One-shot output (the one-shot output time can be set in the range 0.01 to 9999.99s)

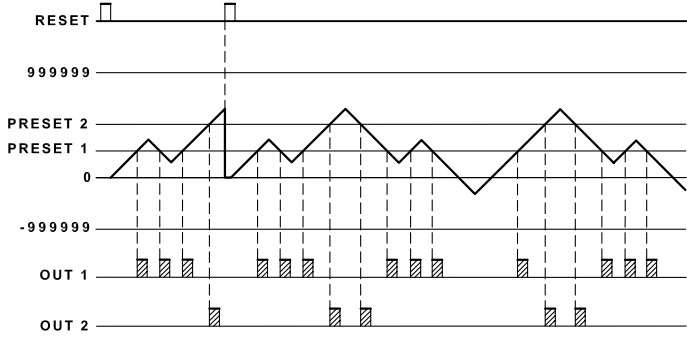
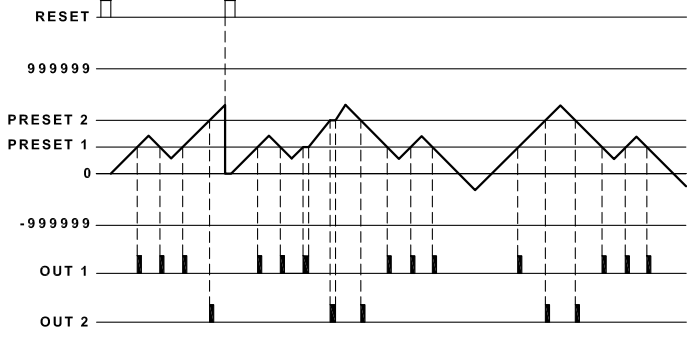
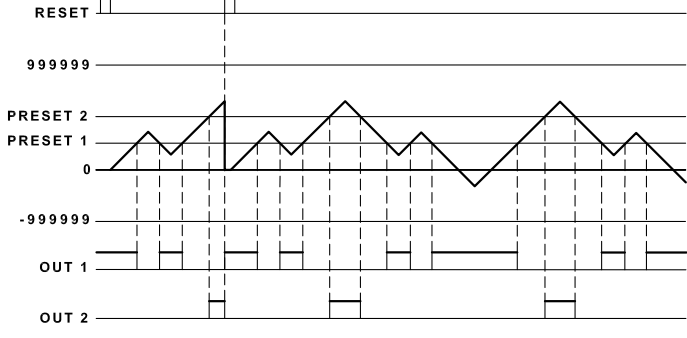
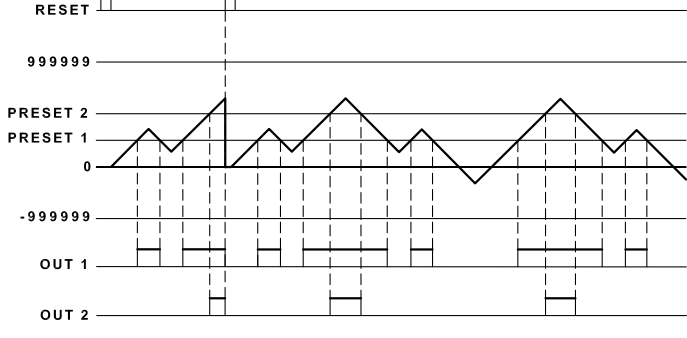
		Output mode	
		UP/DOWN A, B, C	Operation after count completion
Output mode setting	K-2		The display continues to increase/decrease until the overflow or underflow value is reached. One-shot output only.
	D		The display continues to increase/decrease until the overflow or underflow value is reached. The outputs are ON while the count is equal.
	L		The display continues to increase/decrease until the overflow or underflow value is reached. OUT1 is held while the present value is less than or equal to set value 1. OUT2 is held while the present value is less than or equal to set value 2.
	H		The display continues to increase/decrease until the overflow or underflow value is reached. OUT1 is held while the present value is less than or equal to set value 1. OUT2 is held while the present value is less than or equal to set value 2. Note: H mode is available for 2-stage models only.

Note:

1. Counting can not be performed during reset/reset 1 input.
2. If reset/reset 1 is input while one-shot output is ON, one-shot output turns OFF.
3. Do not use the counter function in applications where the count may be completed (again) while one-shot output is ON.

■ Total Operation

TC-Pro48 has a total counter, separate from the 1-stage present counter, for counting the total accumulated value.

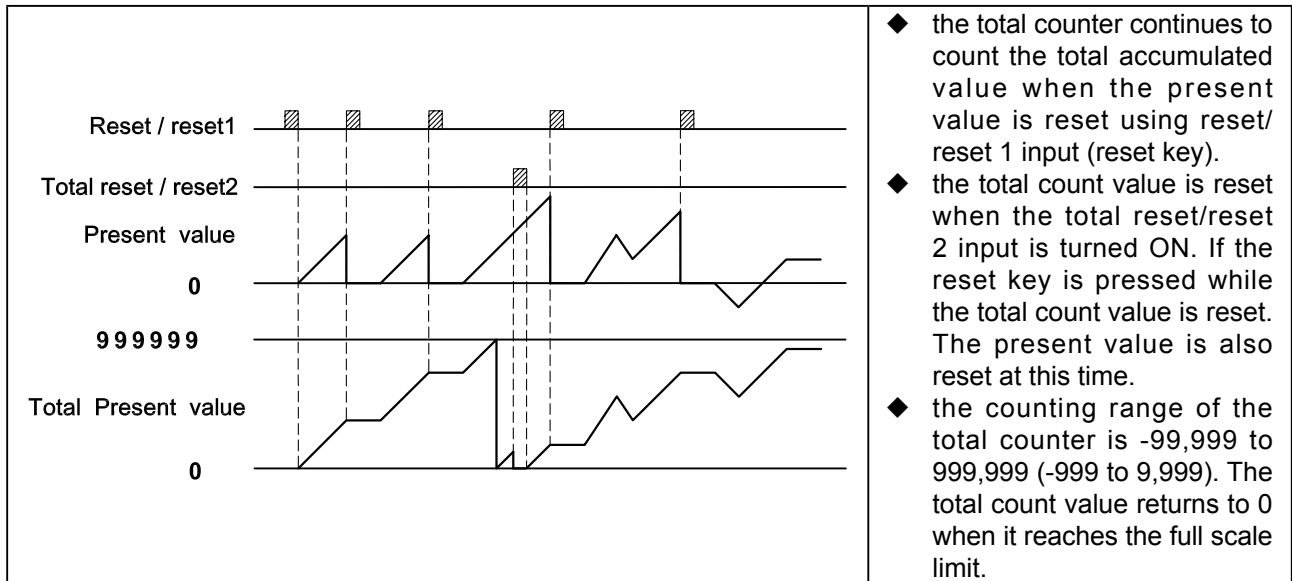

■ Batch Counter Operation

TC-Pro48 has a batch counter, separate from the 1-stage present counter, for counting the number of times the count value returns to 0 when it reaches the full scale limit.

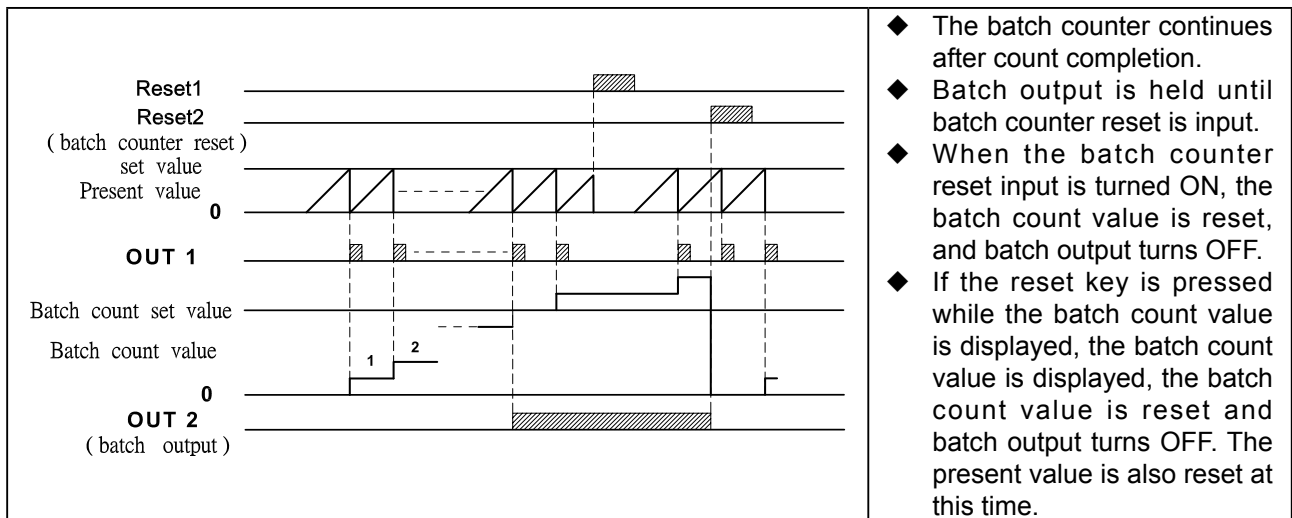

Note:

1. The batch count value is held at 0 during batch counter reset input.
2. If the batch count set is 0, batch count will be performed but there will be no batch output.
3. The batch count value returns to 0 when it reaches 999,999.
4. Once batch input has been turned ON, it will return to the ON state after power interruptions.
5. If the batch count set value is changed from a value that is greater than the batch count value to one that is less, batch output will turn ON.

■ Operation (Dual Counter)

- Using the dual counter allows the count from 2 inputs to be added or subtracted and the result displayed. It is possible to specify a set value for which output turns ON when the set value matches the added or subtracted result.
- OUT1 and OUT2 turn ON and OFF simultaneously.

Dual Count Calculating Mode = ADD Dual count value = CP1 PV + CP2 PV	Dual Count Calculating Mode = SUB Dual count value = CP1 PV - CP2 PV
Note: the above is for when the output mode is N.	Note: the above is for when the output mode is K-2. SUB mode can be used only when K-2, D,L or H is selected as the output mode with 6-digit models.
<ul style="list-style-type: none"> ◆ the operation after count completion for the dual counter value is determined by the output mode. ◆ the CP1 present value is reset when reset 1 input is turned ON and the CP2 present value is reset when reset 2 input is turned ON. ◆ if the reset key is pressed while the dual count value, CP1 present value or CP2 present value is displayed, all of the present values are reset and outputs turn OFF. At this time, counting is not possible for CP1 or CP2 input. 	

Note:

- Counting is not possible for CP1 during reset 1 input. CP2 will not be affected. The dual count value will be calculated based on a CP1 present value of 0.
- Counting is not possible for CP2 during reset 2 input. CP1 will not be affected. The dual count value will be calculated based on a CP2 present value of 0.
- The counting range for dual count value is -99,999 to 999,999.

■ Reset Function List

Function	1-stage/2-stage counter	Total counter		Batch counter		Dual counter	
		Present value/set value	Total count value	Present value/set value	Batch count value/ batch count set value	Dual count value/dual count set value	CP1 present value/ CP2 present value
Screen displayed in run mode	Present value/set value(1,2)	Present value/set value	Total count value	Present value/set value	Batch count value/ batch count set value	Dual count value/dual count set value	CP1 present value/ CP2 present value
Reset/reset 1	Present value and output reset	Present value and output reset		Present value and output reset		Only the CP1 present value is reset	
Total reset/reset 2	No effect	Only the total count value is reset		Batch count value and batch output reset.		Only the CP2 present value is reset	
Reset key	Present value and output reset	Present value and output reset	Present value, total count value, and output reset	Present value and output reset	Present value, batch count value, output and batch output reset.	CP1 present value, CP2 present value, dual count value, and output reset.	

■ Output Mode Settings (Tachometer)

Output mode setting	Upper and lower limit (HI-LO)	<p>(upper-limit) OUT2 set value</p> <p>Measurement value</p> <p>(Lower-limit) OUT1 set value</p> <p>OUT 1</p> <p>OUT 2</p> <p>ON condition for OUT1: measurement values \leq OUT1 set value ON condition for OUT2: measurement value \geq OUT2 set value</p>									
	Area (AREA)	<p>OUT2 set value</p> <p>Measurement value</p> <p>OUT1 set value</p> <p>OUT 1</p> <p>OUT 2</p> <table border="1"> <thead> <tr> <th>Condition</th> <th>OUT1 set values \leq OUT2 set value</th> <th>OUT1 set value $>$ OUT2 set value</th> </tr> </thead> <tbody> <tr> <td>ON condition for OUT1</td> <td>OUT set values \leq Measurement value \leq OUT2 set value</td> <td>OUT2 set values \leq Measurement value \leq OUT1 set value</td> </tr> <tr> <td>ON condition for OUT2</td> <td>Measurement value $<$ OUT1 set value Measurement value $>$ OUT2 set value</td> <td>Measurement value $<$ OUT2 set value Measurement value $>$ OUT1 set value</td> </tr> </tbody> </table>	Condition	OUT1 set values \leq OUT2 set value	OUT1 set value $>$ OUT2 set value	ON condition for OUT1	OUT set values \leq Measurement value \leq OUT2 set value	OUT2 set values \leq Measurement value \leq OUT1 set value	ON condition for OUT2	Measurement value $<$ OUT1 set value Measurement value $>$ OUT2 set value	Measurement value $<$ OUT2 set value Measurement value $>$ OUT1 set value
	Condition	OUT1 set values \leq OUT2 set value	OUT1 set value $>$ OUT2 set value								
	ON condition for OUT1	OUT set values \leq Measurement value \leq OUT2 set value	OUT2 set values \leq Measurement value \leq OUT1 set value								
ON condition for OUT2	Measurement value $<$ OUT1 set value Measurement value $>$ OUT2 set value	Measurement value $<$ OUT2 set value Measurement value $>$ OUT1 set value									
(Upper-limit) (HI-HI)	<p>(Upper-limit) OUT2 set value</p> <p>Measurement value</p> <p>(Lower-limit) OUT1 set value</p> <p>OUT 1</p> <p>OUT 2</p> <p>ON condition for OUT1: measurement value \geq OUT1 set value ON condition for OUT2: measurement value \geq OUT2 set value</p>										
(Lower-limit) (LO-LO)	<p>(Upper-limit) OUT2 set value</p> <p>Measurement value</p> <p>(Lower-limit) OUT1 set value</p> <p>OUT 1</p> <p>OUT 2</p> <p>ON condition for OUT1: Measurement values \leq OUT1 set value ON condition for OUT2: Measurement values \leq OUT2 set value</p>										

Dimensions

Note: all units are in millimeters unless otherwise indicated.

Dimensions without Flush Mounting Adapter

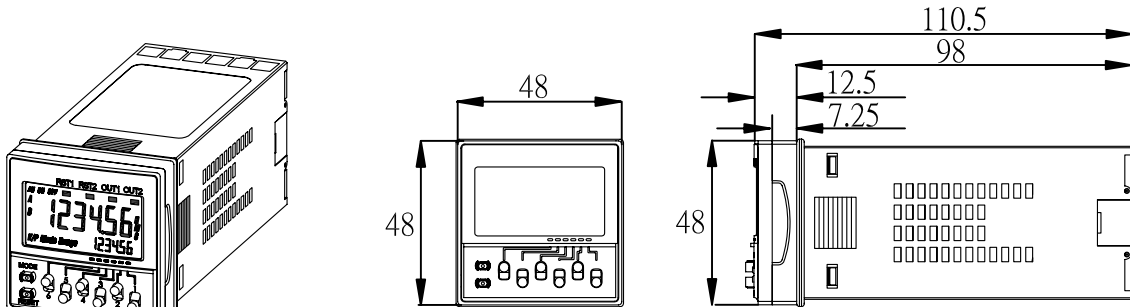

Note: M3 terminal screw (effective length: 8mm)

Dimensions with Flush Mounting Adapter

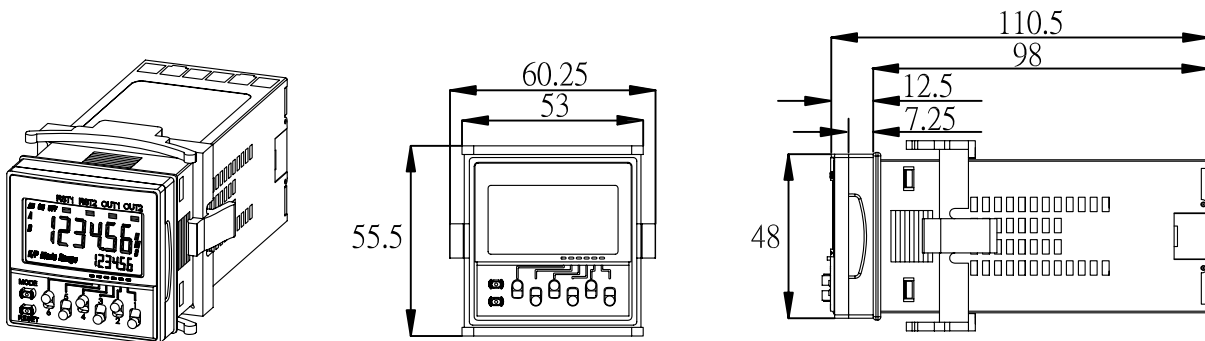

Panel Cutouts

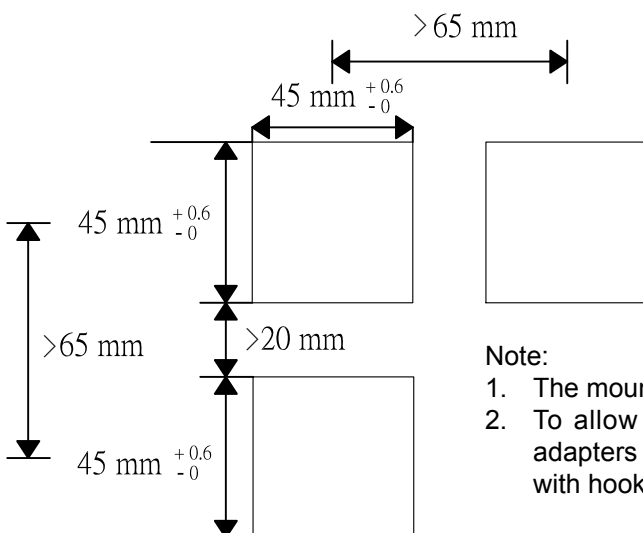

Note:

1. The mounting panel thickness should be 1.5 mm.
2. To allow easier operability, it is recommended that adapters are mounted so that the gap between sides with hooks is at least 20mm.

Dimensions

Note: all units are in millimeters unless otherwise indicated.

Dimensions without DIN Track Mounting Adapter

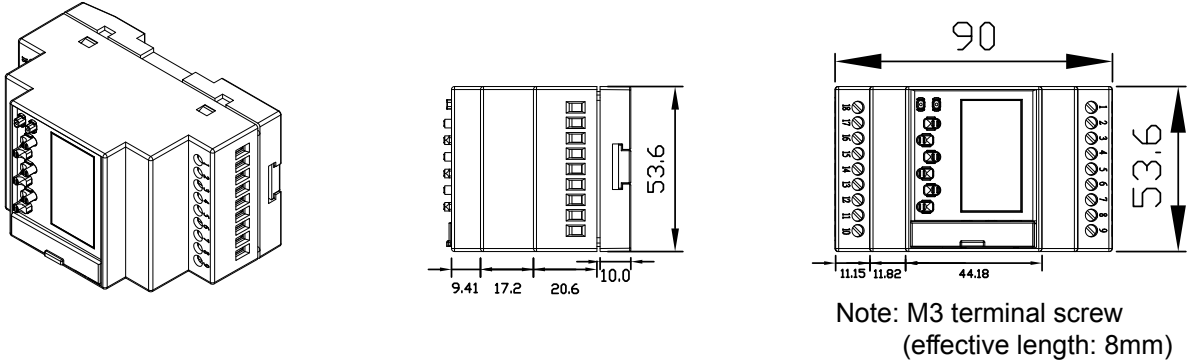

Dimensions without DIN Track Mounting Adapter (with communication)

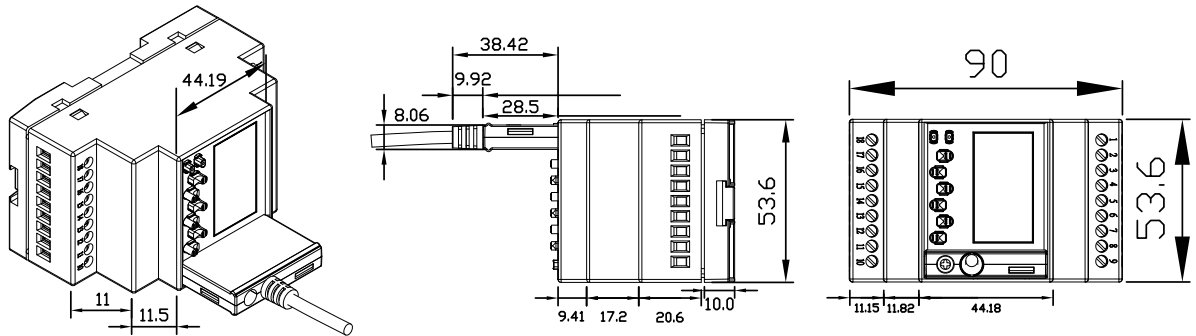

Installation & Accessories

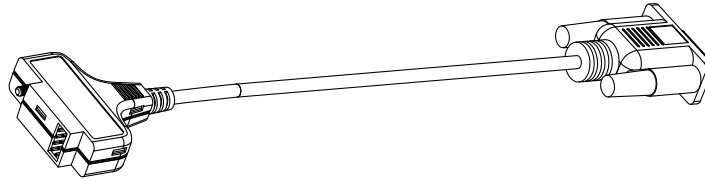
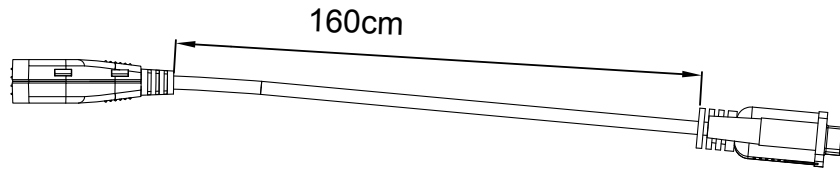

Cable: CAB - 090A□□□(order separately)

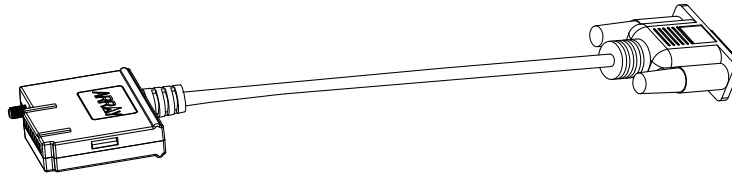
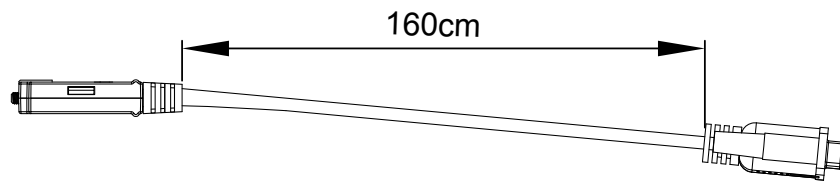

Cable: CAB - 090B□□□(order separately)

Waterproof Packing
PR-43

Flush Mounting Adapter
BK-6

End Plate CAB-44

Mounting Track
0F-A
(order separately)

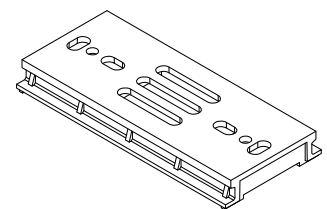
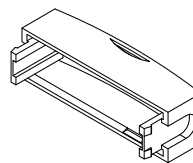
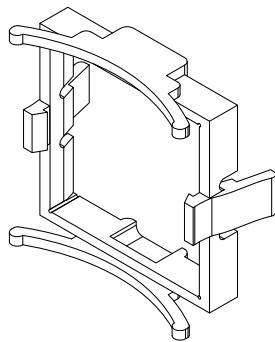
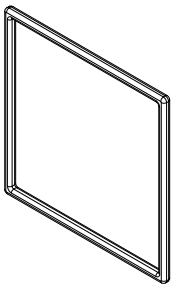

ADP-090401 apdater changing 4 into 9 PIN
(special between 232, 485 and 422,
order separately)

Panel Protective Cover
SVF-A
(order separately)

Communication Protective Cover
TTL-11
(order separately)

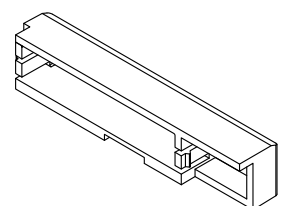
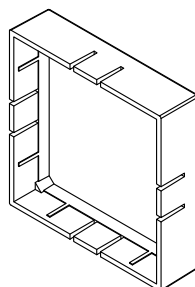
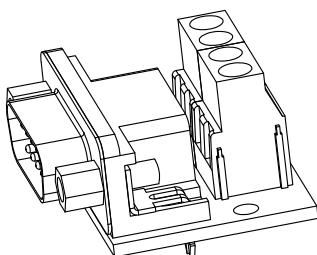

Input Connections

Signal, Reset, and Gate Input

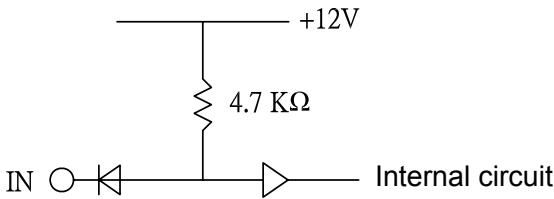

No-voltage Input Signal Levels

No-contact input	Short-circuit level Transistor ON Residual voltage: 3V max. Impedance when ON: 1KΩ min. (the leakage current is 5 to 20 mA when the impedance is 0 Ω)
	Open level Transistor OFF Impedance when OFF: 100KΩ min.
Contact input	Use contact which can adequately switch 5 mA at 10V. The DC voltage must be 30VDC.

No-voltage Inputs (NPN Input)

Open Collector (connection to NPN open collector output sensor)

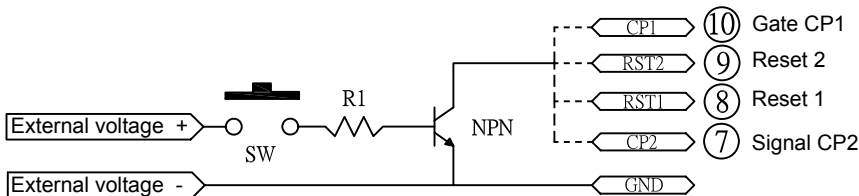

When SW is pressed, the transistor is ON that shows the input has response.

Voltage Inputs (connection to a voltage output sensor)

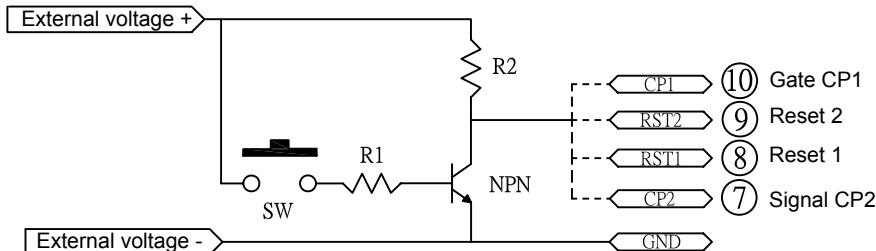

When SW is pressed, the transistor is ON that shows the input has response.

Contact Input

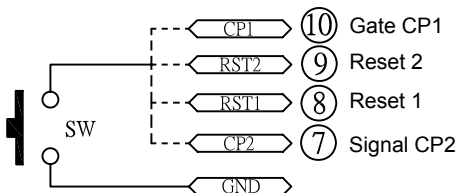

SW is pressed, that shows input the input has response.

Two-wire Sensor

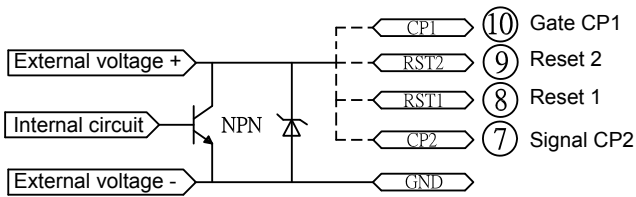

Leakage current: 1.5 mA max.
 Switching capacity: 5 mA min.
 Residual voltage: 3 VDC max.
 Operating voltage: 10 VDC

Voltage inputs (PNP inputs)

No-contact Input (NPN Transistor) (Connection to NPN open collector output sensor)

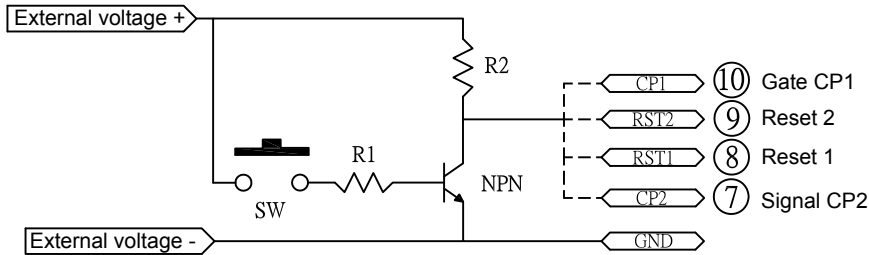

When SW is pressed, the transistor is ON that shows the input has response.

No-contact Inputs (PNP Transistor) (connection to a voltage output sensor)

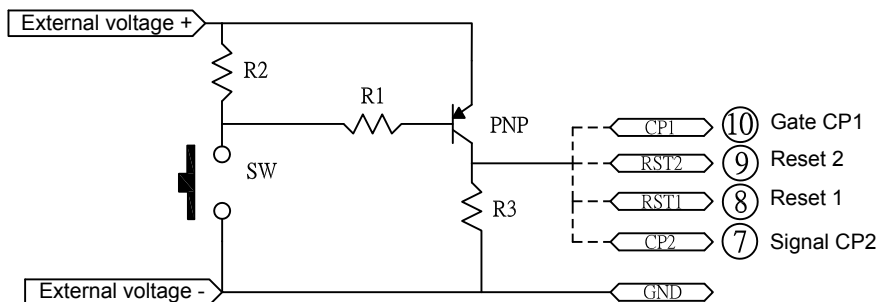

When SW is pressed, the transistor is ON that shows the input has response.

Contact Input

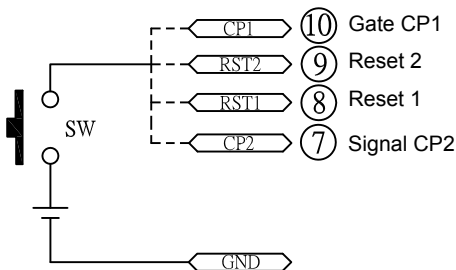

SW is pressed, that shows the input has response.

Safety Precautions

⚠ Caution

- ✓ Do not use the product where corrosive or volatile gases are present, or there may occasionally be a risk of explosion.
- ✓ Usable life of output relay is determined by switch condition. According to the actual usage, use product within its rated load and electrical life expectancy. If using product beyond its life expectancy, its contacts may become fused or there may be a risk of fire.
- ✓ Do not disassemble, repair, or modify the product. Doing so may result in electric shock, fire, or malfunction.
- ✓ Do not allow metal objects or conductive wires to enter the product, which may result in electric shock, fire, or malfunction.

Power Supplies

For the power supply of an input device, use an isolating transformer with the primary and the secondary winding not grounded.

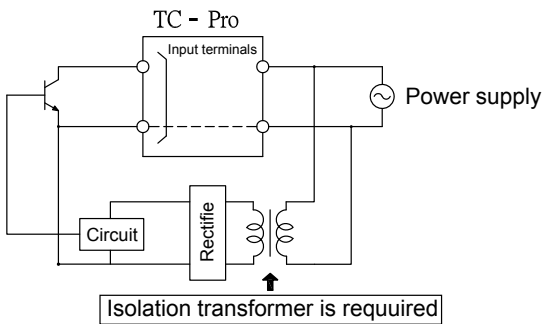

Make sure that the voltage applied is within the specified range, otherwise the internal elements of Timer may be damaged.

Do not touch the input terminals while power is supplied, and so touching the input terminals with power supplied may result in electric shock.

When turning the power ON and OFF, input signal reception is possible, unstable, or impossible.

Turn the power ON and OFF using a relay with a rated capacity

of 10A minimum to prevent contact deterioration due to inrush

current caused by turning the power ON and OFF.

Be sure that the power voltage can be immediately reached to the supply voltage value by relays or switches, otherwise it can not be reset or timing error.

Power Failure Backup

All data is stored in the EEPROM when there is a power failure. The EEPROM can be overwritten more than 100,000 times.

Input and Output

When connecting relay and transformer as an external signal input device, it is necessary to pay attention to the following points to prevent the short circuit because of the hidden current flowing to the power supply. If a relay or transistor connected to two or more timers, those input terminals must be connected correctly, otherwise it can cause short circuit.

Incorrect

The contact or transistor as an external input signal

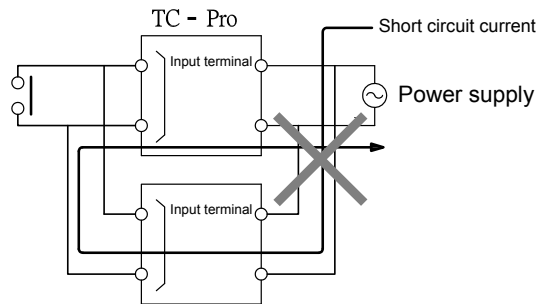

Correct

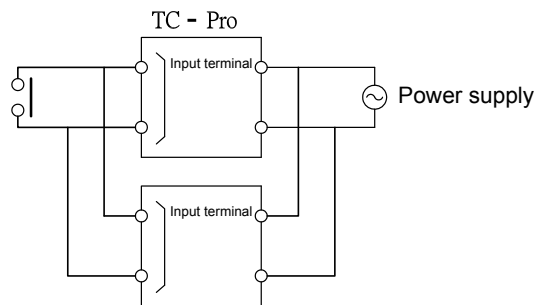

Don't connect the unattached power switch as below, and without considering whether the timer is different or not.

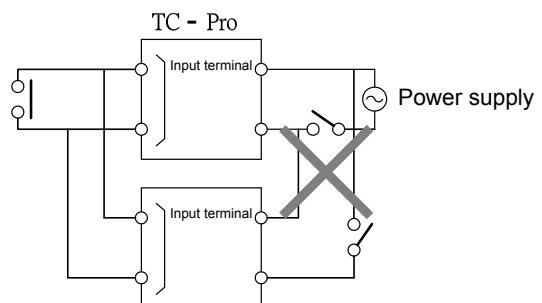

Response time when resetting

The following table shows the delay from when the reset signal is input until the output is turned OFF.

Min. reset signal width	Output delay time
1ms	0.8~1.2ms
20ms	15~25ms

Transistor Output

The transistor output of TC-Pro is insulated from the internal circuitry by a photocoupler, so the transistor output can be used as both NPN and PNP output. The diode connected to the collector of the output transistor is used to absorb inverted voltage that is generated when an inductive load is connected to TC-Pro.

The transistor output of TC-Pro is insulated from the internal circuitry by a photocoupler, so the transistor output can be used as both NPN and PNP output. The diode connected to the collector of the output transistor is used to absorb inverted voltage that is generated when an inductive load is connected to TC-Pro.

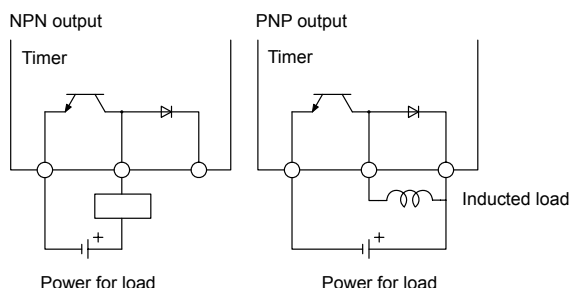

Changing the set values

When changing the set value during a timing operation, the output will turn ON if the set value is changed as follows because of the use of a constant read-in system:

Elapsed time(up) mode: present value \geq set value
 Remaining time(DOWN) mode: elapsing time \geq set value (the present value is set to 0)

Note: when in the remaining time mode, the amount the set value is changed is added to or subtracted from the present value.

Connection

Make sure that wiring is correct.

Mounting

Tighten two mounting screws on the adapter. Tighten them alternately, a little at a time, so as to keep them at an equal tightness. TC-Pro panel surface is water-resistant. In order to prevent the internal circuit from water penetration through the space between the TC-Pro and operating panel, attach a waterproof packing between TC-Pro and installation panel and secure the waterproof packing with the BK-62 flush-mounting adapter.

Operation environment

- √ Use the product within the rating specified for submerging in water and exposure to oil.
- √ Do not use in location affected by excessive vibration or shock.
- √ Do not use the product in locations subject to dust, corrosive gases, or direct sunlight.
- √ Separate the input signal devices, input signal cables, and the product from the source of noise or high-tension cables producing noise.
- √ Separate the product from the source of static electricity when using the product in an environment where a large amount of static electricity is produced (e.g. forming compounds, powders, or fluid materials being transported by pipe).
- √ Organic solvents (such as paint thinner), as well as very acidic or basic solutions might damage the outer casing of the TC-Pro.
- √ Use the product within the rating specified for temperature and humidity.
- √ Do not use the product in locations where condensation may occur due to high humidity or where temperature changes are severe.
- √ Store at the specified temperature. If TC-Pro has been stored at a temperature of less than -10°C , allow TC-Pro to stand at room temperature for at least 3 hours before use.

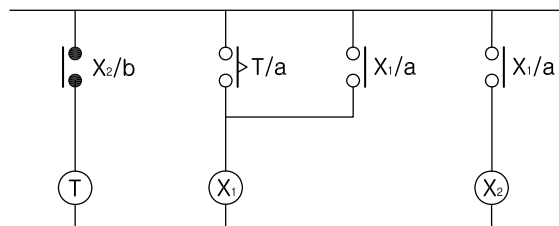

Note: ⊗ auxiliary relay (e.g. MY relay)

Insulation

There is basic insulation between power supply and output terminals. Input and output terminals are connected to devices without exposed charged parts. Input and output terminals are connected to devices with basic insulation that is suitable for the maximum operating voltage.

Additional Information (Using the operation keys)

■ Timer Operation

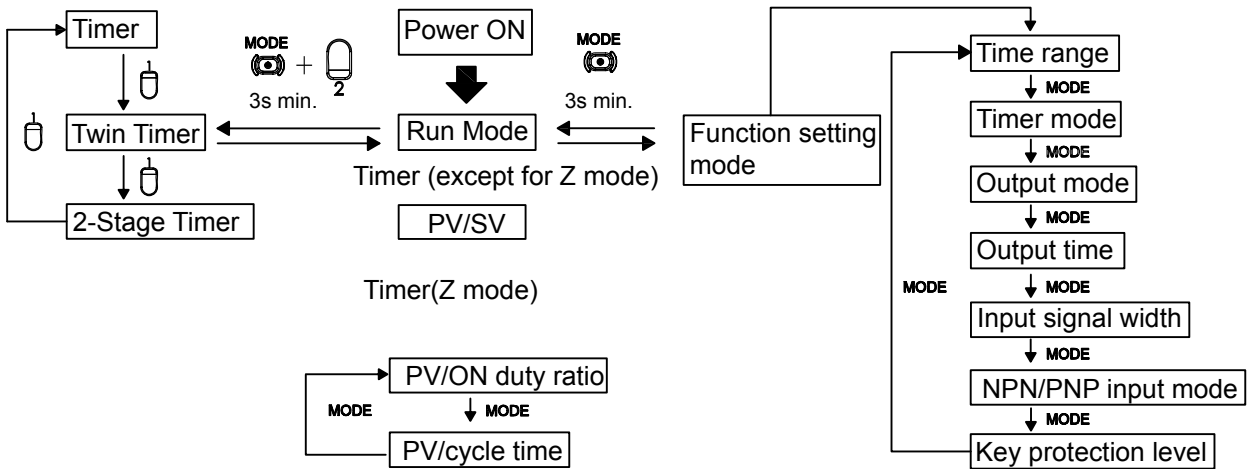

■ Twin Timer Operation

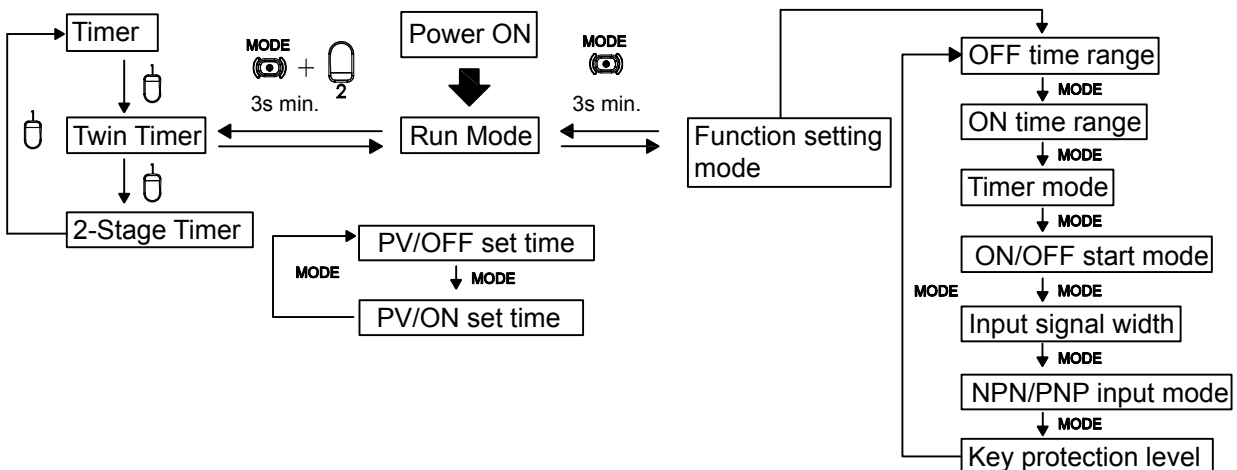

Note: For details on the above flowcharts, refer to page 12 (timer function), or page 15 (twin timer function).

■ 2-Stage Timer Operation

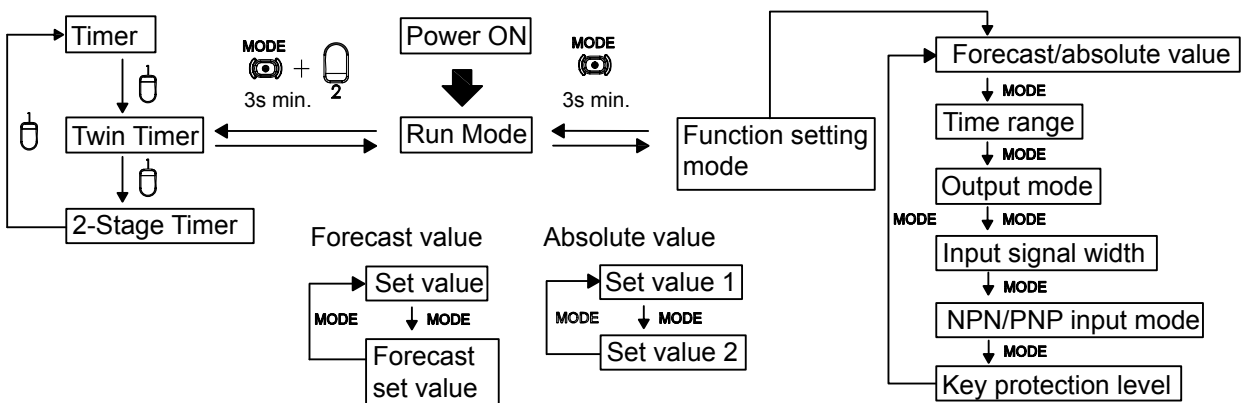

Note: For details on the above flowcharts, refer to page 17. (2-stage timer operation)

Counter Operation

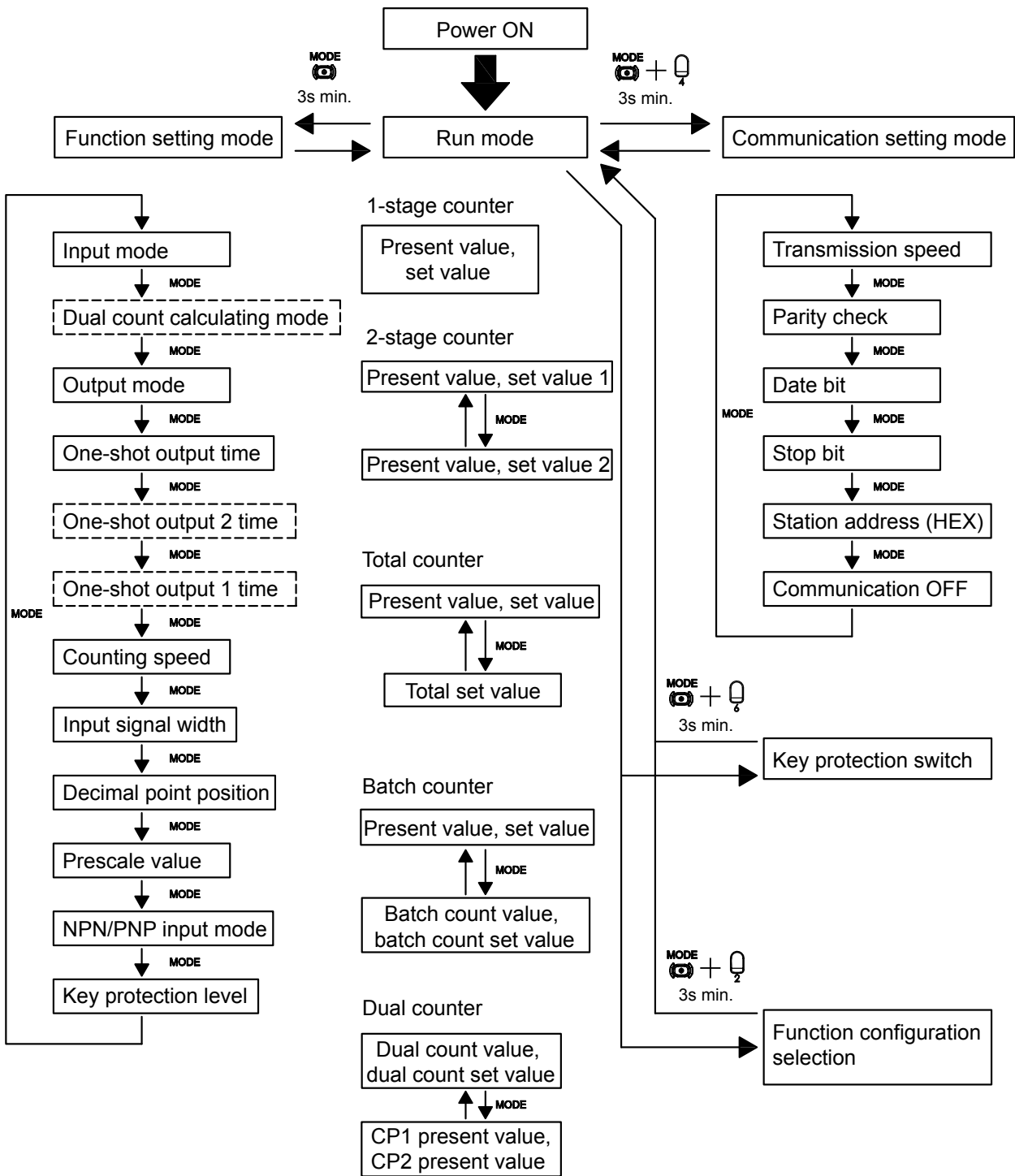

Tachometer Operation

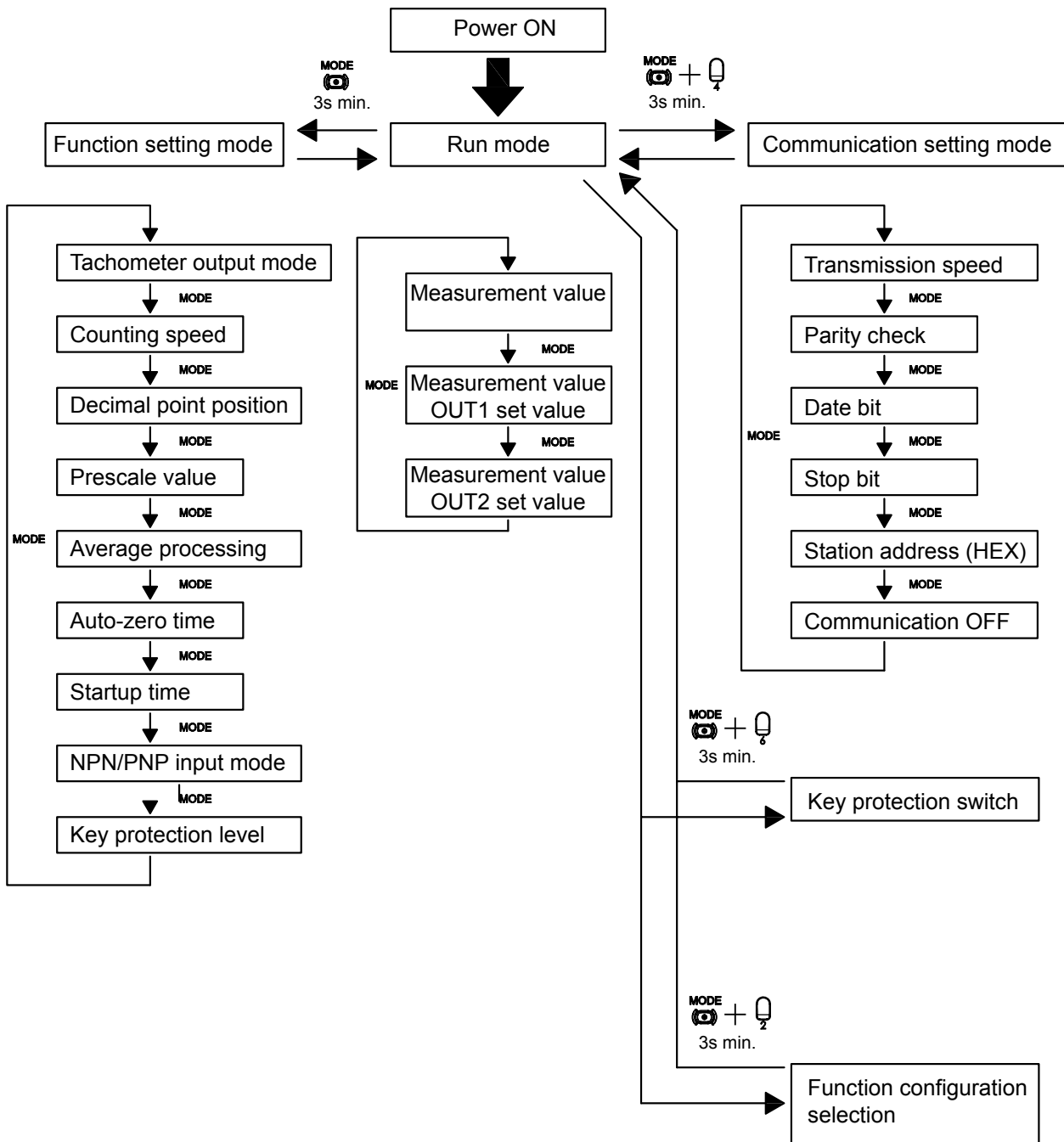

List of Settings

■ Timer/Twin Timer/2-Stage Timer Selection Mode

Fill in your set values in the set value column of the following tables and utilize the tables for quick reference.

Parameter name	parameter	Setting range	Default value	Unit	Set value
Timer/Twin Timer/2-Stage Timer Selection	func	tim/twin/pst	timt	---	

■ Settings for Timer Operation

Run mode when output mode is not Z

Parameter name	parameter	Setting range	Default value	Unit	Set value
Set value	---	0000.00~9999.99 (Time range: -.s)	0000.00	s	
	---	00000.0~99999.9 (Time range: -.s)	00000.0	s	
	---	000000~999999 (Time range: --s)	000000	s	
	---	0000:00~9999:59 (Time range: -min:-s)	0000:00	min:s	
	---	00000.0~99999.9 (Time range: -.min)	00000.0	min	
	---	000000~999999 (Time range: --min)	000000	min	
	---	0000:00~9999:59 (Time range: -h:-min)	0000:00	h:min	
	---	00000.0~99999.9 (Time range: -.h)	00000.0	h	
	---	000000~999999 (Time range: --h)	000000	h	
Present value	---	000.000~999.999 (Time range: -.s)	000.000	s	
Present value	---	Same as set value	Same as left	Same as left	

Run mode when output mode is Z

Parameter name	parameter	Setting range	Default value	Unit	Set value
Cycle time	---	0000.00~9999.99 (Time range: -.s)	0000.00	s	
	---	00000.0~99999.9 (Time range: ---.s)	00000.0	s	
	---	000000~999999 (Time range: ----s)	000000	s	
	---	0000:00~9999:59 (Time range: --min:--s)	0000:00	min:s	
	---	00000.0~99999.9 (Time range: ---.min)	00000.0	min	
	---	000000~999999 (Time range: ----min)	000000	min	
	---	0000:00~9999:59 (Time range: --h:--min)	0000:00	h:min	
	---	00000.0~99999.9 (Time range: ---.h)	00000.0	h	
	---	000000~999999 (Time range: ----h)	000000	h	
Present value	---	000.000~999.999 (Time range: -.---s)	000.000	s	
Present value	---	Same as cycle time above	Same as left	Same as left	
ON duty ratio	---	0~100	0	%	
Present value	---	Same as cycle time above	Same as left	Same as left	

Function Setting Mode

Parameter name	parameter	Setting range	Default value	Unit	Set value
Time range	timr	--.s/---.s/----s/--min:--s/---.min/ ----min/--h:--min/---.h/---h/-.s	--.s	---	
Timer mode	timm	up/down	up	---	
Output mode	outm	a/a-1/a-2/a-3/b/b-1/d/e/f/z	a	---	
Output time	otim	hold/0000.01~9999.99	hold	s	
Input signal width	iflt	20ms/1ms	20ms	---	
NPN/PNP input mode	imod	nnp/npn	nnp	---	
Key protect level	kypt	kp-1/kp-2/kp-3/kp-4/kp-5	kp-1	---	

■ Settings for Twin Timer Operation**Run mode**

Parameter name	parameter	Setting range	Default value	Unit	Set value
OFF set time	---	0000.00~9999.99 (Time range: -.s)	0000.00	s	
	---	00000.0~99999.9 (Time range: -.s)	00000.0	s	
	---	000000~999999 (Time range: --s)	000000	s	
	---	0000:00~9999:59 (Time range: -min-s)	0000:00	min:s	
	---	00000.0~99999.9 (Time range: --min)	00000.0	min	
	---	000000~999999 (Time range: --min)	000000	min	
	---	0000:00~9999:59 (Time range: -h-min)	0000:00	h:min	
	---	00000.0~99999.9 (Time range: --h)	00000.0	h	
	---	000000~999999 (Time range: --h)	000000	h	
Present value	---	Same as OFF time above	Same as left	Same as left	
ON duty ratio	---	Same as OFF time above	Same as left	Same as left	
Present value	---	Same as OFF time above	Same as left	Same as left	

Function setting mode

Parameter name	parameter	Setting range	Default value	Unit	Set value
OFF time range	oftr	--.s/---.s/----s/--min:--s/---.min/ ----min/--h:--min/---.h/---h/-.s	--.s	---	
ON time range	ontr	--.s/---.s/----s/--min:--s/---.min/ ----min/--h:--min/---.h/---h/-.s	--.s	---	
Timer mode	timm	up/down	up	---	
ON/OFF start mode	totm	toff/ton	toff	---	
Input signal width	iflt	20ms/1ms	20ms	---	
NPN/PNP input mode	imod	nnp/npn	nnp	---	
Key protection level	kypt	kp-1/kp-2/kp-3/kp-4/kp-5	kp-1	---	

■ Settings for 2-Stage Timer Operation

Run mode

Parameter name		parameter	Setting range	Default value	Unit	Set value
Present value setting	Set value	---	0000.00~9999.99 (Time range: -.s)	0000.00	s	
		---	00000.0~99999.9 (Time range: -.s)	00000.0	s	
		---	000000~999999 (Time range: --s)	000000	s	
		---	0000:00~9999:59 (Time range: -min-s)	0000:00	min:s	
		---	00000.0~99999.9 (Time range: -.min)	00000.0	min	
		---	000000~999999 (Time range: --min)	000000	min	
		---	0000:00~9999:59 (Time range: -h-min)	0000:00	h:min	
		---	00000.0~99999.9 (Time range: -.h)	00000.0	h	
		---	000000~999999 (Time range: --h)	000000	h	
	---	000.000~999.999 (Time range: -.s)	000.000	s		
	Present value	---	Same as the present value of the set value above	Same as left	Same as left	
	Present setting value	---	Same as the present value of the set value above	Same as left	Same as left	
	Present value	---	Same as the present value of the set value above	Same as left	Same as left	
absolute value setting	Set value 1		Same as the present value of the set value above	Same as left	Same as left	
	Present value		Same as the present value of the set value above	Same as left	Same as left	
	Set value 2		Same as the present value of the set value above	Same as left	Same as left	
	Present value		Same as the present value of the set value above	Same as left	Same as left	

Function setting mode

Parameter name	parameter	Setting range	Default value	Unit	Set value
forecast/absolute value	setl	ofst/abs	ofst	---	
Time range	timr	--.s/---.s/---s/--min--s/---.min/ ---min/--h--min/---.h/---h/-.s	--.s	---	
Output mode	outm	a/f-1	a	---	
Input signal width	iflt	20ms/1ms	20ms	---	
NPN/PNP input mode	imod	npn/npn	npn	---	
Key protection level	kypt	kp-1/kp-2/kp-3/kp-4/kp-5	kp-1	---	

List of Settings

Fill in your set values in the set value column of the following tables and utilize the tables for quick reference.

Key protection switch mode

Parameter name	parameter	Setting range	Default value	Unit	Set value
Key protection selection	kp	off/on	off	---	

Communication setting mode

Parameter name	parameter	Setting range	Default value	Unit	Set value
Transmission speed	baud	12/24/48/96/144/192/288/384/576	96	Bps	
Parity Check	pari	none/odd/even	none	---	
Date bit	data	8bit/7bit	8bit	bits	
Stop bit	stop	1bit/sbit	1bit	bit	
Station address (Hex)	addr	01 to ff	01	---	
Communication OFF	cosh	on/off	on	---	

■ 1-stage Counter/2-Stage Counter/Total Counter/Batch Counter/ Dual Counter / Tachometer Selection Mode

Parameter configuration selection mode

Parameter name	parameter	Setting range	Default value	Unit	Set value
Configuration selection	func	1cnt/2cnt/tcnt/bcnt/dcnt/taco	1cnt	---	

■ Setting for Counter Operation

Run Mode

1-stage counter

Parameter name	parameter	Setting range	Default value	Unit	Set value
Present value	---	-99999~999999	000000	---	
Set value		000000~999999 (For conditions other than those described in note 1.)	000000	---	
		-99999~999999 (See note 1.)			

2-stage counter

Parameter name		parameter	Setting range	Default value	Unit	Set value
Screen 1	Present value	---	-99999~999999	000000	---	
	Set value 1	---	000000~999999 (For conditions other than those described in note 1.)			
			-99999~999999 (See note 1.)			
Screen 2	Present value	---	-99999~999999	000000	---	
	Set value 2	---	000000~999999 (For conditions other than those described in note 1.)			
			-99999~999999 (See note 1.)			

Total and preset counter

Parameter name		parameter	Setting range	Default value	Unit	Set value
Screen 1	Present value	---	-99999~999999	000000	---	
	Set value 1	---	000000~999999 (For conditions other than those described in note 1.)			
			-99999~999999 (See note 1.)			
Screen 2	Total count value	---	-99999~999999	000000	---	

Batch counter

Parameter name		parameter	Setting range	Default value	Unit	Set value
Screen 1	Present value	---	-99999~999999	000000	---	
	Set value	---	000000~999999 (For conditions other than those described in note 1.)			
			-99999~999999 (See note 1.)			
Screen 2	Batch count value	---	000000~999999	000000	---	
	Batch count set value	---	000000~999999			

Dual counter

Parameter name		parameter	Setting range	Default value	Unit	Set value
Screen 1	Dual count value	---	-99999~999999	000000	---	
	Dual count set value	---	000000~999999 (For conditions other than those described in note 2.)			
			-99999~999999 (See note 2.)			
Screen 2	CP1 Present value	---	-99999~999999	000000	---	
	CP2 Present value	---	000000~999999 (For conditions other than those described in note 1.)			
			-99999~999999 (See note 1.)			

Note:

1. The input mode is increment/decrement mode and the output mode is K-2, D, L or H.
2. The dual count calculating mode is subtraction mode and the output mode is K-2, D, L, or H.

Function setting mode

Parameter name	parameter	Setting range	Default value	Unit	Set value
Input mode	cntm	up/down/ud-a/ud-b/ud-c (See note 1.)	up	---	
Dual count calculating mode	caln	add/sub (See note 1.)	add	---	
Output mode	outm	n/f/c/r/k-1/p/q/a/k-2/d/l/h (See note 2.)	n	---	
One-shot output time	otim	000.001~999.999	000.500	s	
One-shot output 2 time	otm2	000.001~999.999	000.500	s	
One-shot output 1 time	otm1	hold/000.001~999.999 (See note 3)	hold	s	
Counting speed	cnts	30Hz/5KHz	30hz	---	
Input signal width	iflt	20ms/1ms	20ms	---	
Decimal point position	dp	----/---./-./-./-./---	----	---	
Prescale value	pscl	000.001~999.999	001.000	---	
NPN/PNP Input mode	imod	NPN/PNP	NPN	---	
Key protection level	kypt	kp-1/kp-2/kp-3/kp-4/kp-5	kp-1	---	

Note:

1. The setting range varies with the output mode.
2. The setting range varies with the model and the input mode.
3. HOLD can not be set when the output mode is K-2.

■ Setting for tachometer operation

Run mode

Parameter name	parameter	Setting range	Default value	Unit	Set value
Measurement value	---	000000~999999	000000	---	---
Measurement value	---	000000~999999	000000	---	---
OUT1 set value	---	000000~999999	000000	---	
Measurement value	---	000000~999999	000000	---	---
OUT2 set value	---	000000~999999	000000	---	

Function setting mode

Parameter name	parameter	Setting range	Default value	Unit	Set value
Tachometer output mode	totm	hilo/area/hihi/lolo	hilo	---	
Counting speed	cnts	30Hz/10KHz	----	---	
Decimal point position	dp	---/---./-/-.-/-.-	001.000	---	
Prescale value	pscl	000.001~999.999	001.000	---	
Average processing	aug	off/2/4/8	off	---	
Auto-zero time	autz	00.01~99.99	99.99	s	
Startup time	stmr	00.01~99.99	00.00	s	
NPN/PNP Input time	imod	NPN/PNP	NPN	---	
Key protect level	kypt	kp-1/kp-2/kp-3/kp-4/kp-5	kp-1	---	

Comparison Table:

